



Wilshire Planters Weathering Steel Rectangle & Square

Weathering Steel planters offer a warm industrial aesthetic favored by many landscape architects. The natural red-orange oxidization forms a protective patina that develops and regenerates continuously. Our A588 and A606 grade steel planters are meticulously assembled and welded.

Weathering Steel or Pre-Weathered Steel

Our Weathering Steel ships with a natural mill scale finish. The initial oxidation develops within weeks and evolves over time. Pre-Weathered Steel products undergo an earth-friendly pre-treatment, which steps up the oxidation process timeline to help achieve the desired visual result faster.

Wilshire Planters, Weathering Steel, Rectangle & Square

WILSHIRE PLANTERS, WEATHERING STEEL RECTANGLES & SQUARES

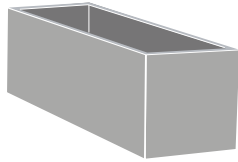

Rectangle

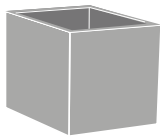

Square

THE COMPLETE WILSHIRE COLLECTION

For additional shapes and materials, visit tournesol.com/collections/wilshire

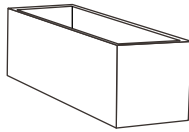

Rectangle

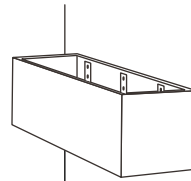

Hanging Box

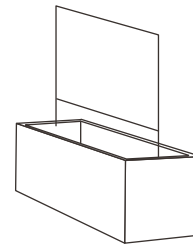

Trellis, Laser-Cut Screen

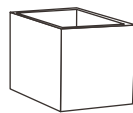

Square

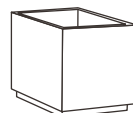

Toe Kick

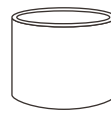

Round



Round with Toe Kick

OPTIONS

Standard Wilshire Planters can be modified with a broad array of options without incurring custom charges. Options are limited to those products that can support them. Speak to a Tournesol Advisor to discuss which options will work with your project.



Irrigation



Change Dimension



Accessory Pockets



Scoops



Casters



Drain Holes



Toe Kick



Tie Downs



Pre-Weathering Treatment

Wilshire Planters, Weathering Steel, Rectangle & Square

Weathering Steel

Our Weathering Steel ships with a natural mill scale finish. The initial oxidation develops within weeks and evolves over time. Environmental conditions such as humidity, salt, and the temperature at installation can affect rust uniformity and formation rate. The color develops from a vibrant orange to a deep reddish-brown.

Pre-Weathered Steel

Our Pre-Weathered Steel products undergo an earth-friendly pre-treatment, which steps up the oxidation process timeline to help achieve the desired visual result faster.

Our process begins by grit-blasting the raw mill scale surface; next we treat it with an all-natural solution of hydrogen peroxide, vinegar, and salt. Treated products cure for a day before being individually wrapped in paper and then plastic before shipping.

Raw mill scale steel and treated surfaces can be powdery and may show markings during delivery and installation. These changes are affected by humidity levels and storage.

Weathering Steel products should be unwrapped upon arrival and stored indoors if possible. Shedding during unpacking and storing may occur; protect flooring during storage and installation.

TOP LIP

Wilshire Planters in Weathering Steel come with a standard lip return.

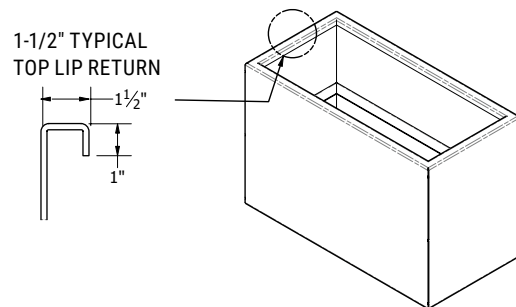

BASE OPTION

Wilshire Planters are available with a toe kick option.

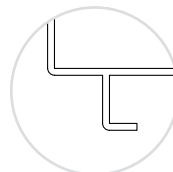

WWR-RE

Toe kick option
2"H bottom reveal

DRAINAGE

Drain Holes: Standard drain holes are 1-5/8" diameter, made free-of-charge at the factory.

Wilshire Planters Weathering Steel, Rectangle & Square

- 12-gauge A588 and A606 Steel
- Engineered to resist deformation
- Fully welded corners
- Optional toe kick available
- Drain holes standard

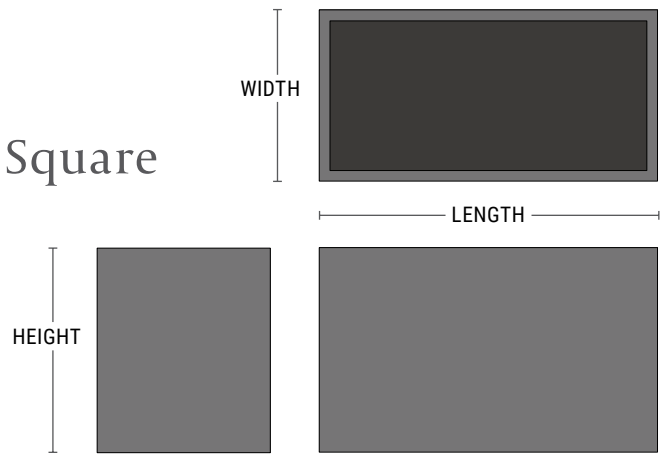

PRODUCT	SHAPE	LENGTH	WIDTH	HEIGHT	WEIGHT (LBS.)	VOLUME (CUBIC FT.)	INTERIOR TOP	IRRIGATION
WWR-WS1800	Square	18"	18"	20"	64 lbs.	3.5	15" x 15"	-
WVRT-WS1800	Square - tall	18"	18"	30"	85 lbs.	5.25	15" x 15"	CWM-R2020-MS
WWR-WS241012	Rectangle	24"	10"	12"	36 lbs.	1.47	21" x 7"	CWM-R1109-MS
WWR-WS241218	Rectangle	24"	12"	18"	52 lbs.	2.74	21" x 9"	CWM-R1614-MS
WWR-WS241818	Rectangle	24"	18"	18"	64 lbs.	4.14	21" x 15"	CWM-R2014-MS
WWR-WS241824	Rectangle	24"	18"	24"	86 lbs.	5.5	21" x 15"	CWM-R2014-MS
WWR-WS241830	Rectangle	24"	18"	30"	94 lbs.	7.08	21" x 15"	CWM-R2020-MS
WWR-WS242418	Square	24"	24"	18"	76 lbs.	5.53	21" x 21"	CWM-R2014-MS
WWR-WS2400	Square	24"	24"	24"	106 lbs.	7.5	21" x 21"	CWC-R1850/CWM-R1114-2k
WVRT-WS2400	Square - tall	24"	24"	48"	170 lbs.	15.25	21" x 21"	CWC-R1850/CWM-R1120-2k
WWR-WS3000	Square	30"	30"	27"	150 lbs.	13	27" x 27"	CWM-R1620-3K/CWM-1720-4K
WWR-WS361012	Rectangle	36"	10"	12"	51 lbs.	2.21	33" x 7"	CWM-R1109-2K
WWR-WS361218	Rectangle	36"	12"	18"	71 lbs.	4.13	33" x 9"	CWM-R1614-MS
WWR-WS361818	Rectangle	36"	18"	18"	85 lbs.	6.23	33" x 15"	CWM-R2014-MS
WWR-WS361824	Rectangle	36"	18"	24"	115 lbs.	8	33" x 15"	CWM-R2014-MS
WWR-WS361830	Rectangle	36"	18"	30"	134 lbs.	10.65	33" x 15"	CWM-R2020-MS
WWR-WS362418	Rectangle	36"	24"	18"	99 lbs.	8.32	33" x 21"	CWM-R2014-MS
WWR-WS362424	Rectangle	36"	24"	24"	132 lbs.	11	33" x 21"	CWM-R2914-MS
WWR-WS362430	Rectangle	36"	24"	30"	153 lbs.	14.24	33" x 21"	CWM-R2920-MS
WWR-WS362436	Rectangle	36"	24"	36"	175 lbs.	17.19	33" x 21"	CWM-R2920-MS

Wilshire Planters Weathering Steel, Rectangle & Square

- 12-gauge A588 and A606 Steel
- Engineered to resist deformation
- Fully welded corners
- Optional toe kick available
- Drain holes standard

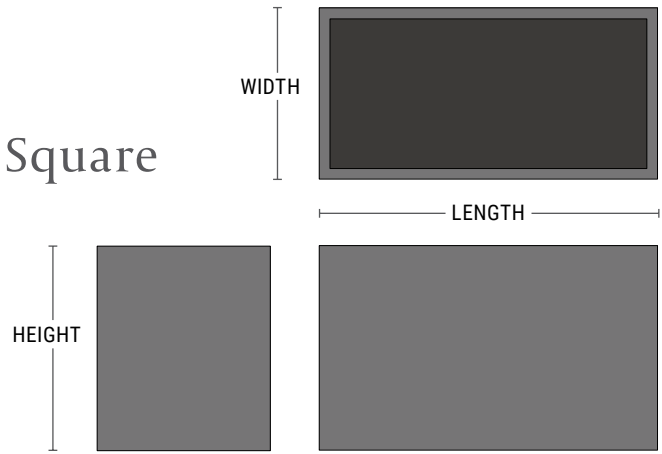

PRODUCT	SHAPE	LENGTH	WIDTH	HEIGHT	WEIGHT (LBS.)	VOLUME (CUBIC FT.)	INTERIOR TOP	IRRIGATION
WWR-WS362442	Rectangle	36"	24"	42"	196 lbs.	20.15	33" x 21"	CWM-R2920-MS
WWR-WS363018	Rectangle	36"	30"	18"	113 lbs.	10.42	33" x 27"	CWM-R2914-MS
WWR-WS363024	Rectangle	36"	30"	24"	137 lbs.	14.13	33" x 27"	CWM-R2920-MS
WWR-WS363030	Rectangle	36"	30"	30"	173 lbs.	17.5	33" x 27"	CWM-R2920-MS
WWR-WS363036	Rectangle	36"	30"	36"	196 lbs.	21.53	33" x 27"	CWM-R2920-MS
WWR-WS363042	Rectangle	36"	30"	42"	220 lbs.	25.23	33" x 27"	CWM-R2920-MS
WWR-WS363618	Square	36"	36"	18"	127 lbs.	12.52	33" x 33"	CWM-R2914-MS
WWR-WS363624	Square	36"	36"	24"	153 lbs.	16.97	33" x 33"	CWM-R2920-MS
WWR-WS3600	Square	36"	36"	30"	204 lbs.	21	33" x 33"	CWM-R1620-2K/CWM-1720-4K
WWR-WS363636	Square	36"	36"	36"	218 lbs.	25.87	33" x 33"	CWM-R2920-MS
WWR-WS363642	Square	36"	36"	42"	243 lbs.	30.31	33" x 33"	CWM-R2920-MS
WWR-WS4200	Square	42"	42"	36"	262 lbs.	35.25	39" x 39"	CWM-R1120-4K/CWM-1720-4K
WWR-WS481012	Rectangle	48"	10"	12"	65 lbs.	2.95	45" x 7"	CWM-R1109-3K
WWR-WS481218	Rectangle	48"	12"	18"	91 lbs.	5.51	45" x 9"	CWM-R1614-2K
WWR-WS481818	Rectangle	48"	18"	18"	107 lbs.	8.31	45" x 15"	CWM-R2014-2K
WWR-WS481824	Rectangle	48"	18"	24"	148 lbs.	11	45" x 15"	CWM-R2014-2k
WWR-WS481830	Rectangle	48"	18"	30"	166 lbs.	14.22	45" x 15"	CWM-R2020-2K
WWR-WS482418	Rectangle	48"	24"	18"	123 lbs.	11.12	45" x 21"	CWM-R2014-2K
WWR-WS482424	Rectangle	48"	24"	24"	169 lbs.	14.5	45" x 21"	CWM-R2014-2k
WWR-WS482430	Rectangle	48"	24"	30"	188 lbs.	19.01	45" x 21"	CWM-R2020-2k

Wilshire Planters Weathering Steel, Rectangle & Square

- 12-gauge A588 and A606 Steel
- Engineered to resist deformation
- Fully welded corners
- Optional toe kick available
- Drain holes standard

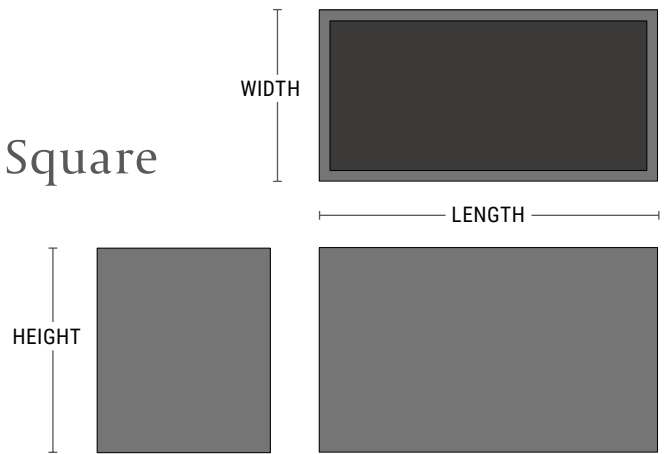

PRODUCT	SHAPE	LENGTH	WIDTH	HEIGHT	WEIGHT (LBS.)	VOLUME (CUBIC FT.)	INTERIOR TOP	IRRIGATION
WWR-WS482436	Rectangle	48"	24"	36"	213 lbs.	22.96	45" x 21"	CWM-R2020-2k
WWR-WS482442	Rectangle	48"	24"	42"	239 lbs.	26.91	45" x 21"	CWM-R2020-2k
WWR-WS483018	Rectangle	48"	30"	18"	139 lbs.	13.92	45" x 27"	CWM-R2014-2k
WWR-WS483024	Rectangle	48"	30"	24"	167 lbs.	18.86	45" x 27"	CWM-R2020-2k
WWR-WS483030	Rectangle	48"	30"	30"	219 lbs.	23.5	45" x 27"	CWM-R2020-2k
WWR-WS483036	Rectangle	48"	30"	36"	237 lbs.	28.75	45" x 27"	CWM-R2020-2k
WWR-WS483042	Rectangle	48"	30"	42"	265 lbs.	33.69	45" x 27"	CWM-R2020-2k
WWR-WS483618	Rectangle	48"	36"	18"	155 lbs.	16.72	45" x 33"	CWM-R2014-2k
WWR-WS483624	Rectangle	48"	36"	24"	185 lbs.	22.66	45" x 33"	CWM-R2020-2k
WWR-WS483630	Rectangle	48"	36"	30"	231 lbs.	28.6	45" x 33"	CWM-R2020-2k
WWR-WS483636	Rectangle	48"	36"	36"	261 lbs.	34.54	45" x 33"	CWM-R2020-2k
WWR-WS483642	Rectangle	48"	36"	42"	291 lbs.	40.48	45" x 33"	CWM-R2020-2k
WWR-WS484818	Rectangle	48"	48"	18"	187 lbs.	22.33	45" x 45"	CWM-R2014-2k
WWR-WS484824	Square	48"	48"	24"	239 lbs.	30.25	45" x 45"	CWM-R2014-4K
WWR-WS484830	Square	48"	48"	30"	274 lbs.	38.19	45" x 45"	CWM-R2020-2k
WWR-WS484800	Square	48"	48"	36"	344 lbs.	45.5	45" x 45"	CWM-R2920-4k
WWR-WS484842	Square	48"	48"	42"	342 lbs.	54.05	45" x 45"	CWM-R2020-2k
WWR-WS601012	Rectangle	60"	10"	12"	79 lbs.	3.69	57" x 7"	CWM-R1109-3K
WWR-WS601218	Rectangle	60"	12"	18"	110 lbs.	6.89	57" x 9"	CWM-R1614-3K
WWR-WS601818	Rectangle	60"	18"	18"	128 lbs.	10.4	57" x 15"	CWM-R2014-2K

Wilshire Planters Weathering Steel, Rectangle & Square

- 12-gauge A588 and A606 Steel
- Engineered to resist deformation
- Fully welded corners
- Optional toe kick available
- Drain holes standard

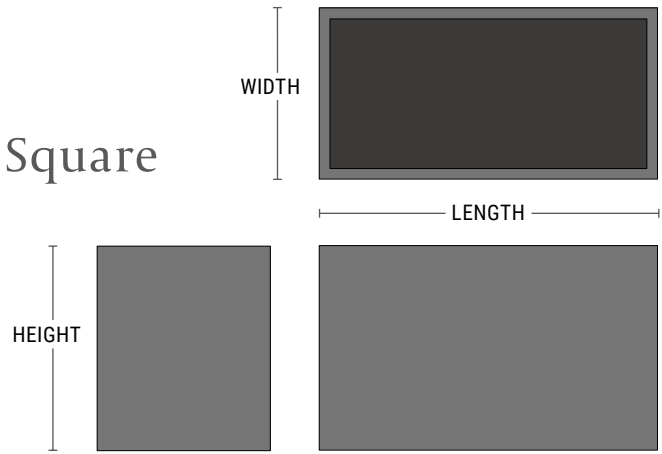

PRODUCT	SHAPE	LENGTH	WIDTH	HEIGHT	WEIGHT (LBS.)	VOLUME (CUBIC FT.)	INTERIOR TOP	IRRIGATION
WWR-WS601824	Rectangle	60"	18"	24"	177 lbs.	14	57" x 15"	CWM-R2014-2k
WWR-WS601830	Rectangle	60"	18"	30"	198 lbs.	17.79	57" x 15"	CWM-R2020-2K
WWR-WS602418	Rectangle	60"	24"	18"	146 lbs.	13.91	57" x 21"	CWM-R2014-2K
WWR-WS602424	Rectangle	60"	24"	24"	200 lbs.	18.5	57" x 21"	CWM-R2014-2k
WWR-WS602430	Rectangle	60"	24"	30"	222 lbs.	23.78	57" x 21"	CWM-R2020-2k
WWR-WS602436	Rectangle	60"	24"	36"	252 lbs.	28.72	57" x 21"	CWM-R2020-2k
WWR-WS602442	Rectangle	60"	24"	42"	298 lbs.	33.66	57" x 21"	CWM-R2020-2k
WWR-WS603018	Rectangle	60"	30"	18"	164 lbs.	17.41	57" x 27"	CWM-R2014-2k
WWR-WS603024	Rectangle	60"	30"	24"	197 lbs.	23.6	57" x 27"	CWM-R2020-2k
WWR-WS603030	Rectangle	60"	30"	30"	256 lbs.	29	57" x 27"	CWM-R2020-2k
WWR-WS603036	Rectangle	60"	30"	36"	278 lbs.	35.97	57" x 27"	CWM-R2020-2k
WWR-WS603042	Rectangle	60"	30"	42"	327 lbs.	42.15	57" x 27"	CWM-R2020-2k
WWR-WS603618	Rectangle	60"	36"	18"	183 lbs.	20.92	57" x 33"	CWM-R2014-2k
WWR-WS603624	Rectangle	60"	36"	24"	217 lbs.	28.35	57" x 33"	CWM-R2020-2k
WWR-WS603630	Rectangle	60"	36"	30"	269 lbs.	35.78	57" x 33"	CWM-R2020-2k
WWR-WS603636	Rectangle	60"	36"	36"	304 lbs.	43.21	57" x 33"	CWM-R2020-2k
WWR-WS603642	Rectangle	60"	36"	42"	356 lbs.	50.64	57" x 33"	CWM-R2020-2k
WWR-WS604818	Rectangle	60"	48"	18"	219 lbs.	27.94	57" x 45"	CWM-R2014-2k
WWR-WS604824	Rectangle	60"	48"	24"	257 lbs.	37.86	57" x 45"	CWM-R2020-2k
WWR-WS604830	Rectangle	60"	48"	30"	317 lbs.	47.78	57" x 45"	CWM-R2020-2k

Wilshire Planters Weathering Steel, Rectangle & Square

- 12-gauge A588 and A606 Steel
- Engineered to resist deformation
- Fully welded corners
- Optional toe kick available
- Drain holes standard

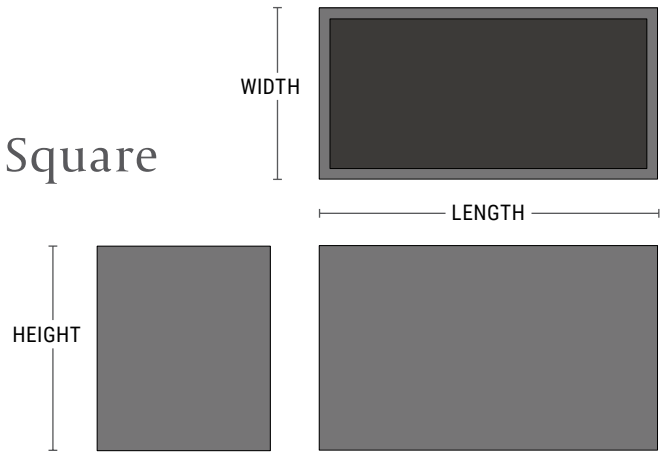

PRODUCT	SHAPE	LENGTH	WIDTH	HEIGHT	WEIGHT (LBS.)	VOLUME (CUBIC FT.)	INTERIOR TOP	IRRIGATION
WWR-WS604836	Rectangle	60"	48"	36"	355 lbs.	57.7	57" x 45"	CWM-R2020-3k
WWR-WS604842	Rectangle	60"	48"	42"	414 lbs.	67.62	57" x 45"	CWM-R2020-2k
WWR-WS6000	Square	60"	60"	42"	450 lbs.	84.5	57" x 57"	CWM-2920-4K
WWR-WS721012	Rectangle	72"	10"	12"	93 lbs.	4.43	69" x 7"	CWM-R1109-4K
WWR-WS721218	Rectangle	72"	12"	18"	129 lbs.	8.28	69" x 9"	CWM-R1614-3K
WWR-WS721818	Rectangle	72"	18"	18"	149 lbs.	12.49	69" x 15"	CWM-R2014-3K
WWR-WS721824	Rectangle	72"	18"	24"	210 lbs.	16.5	69" x 15"	CWM-R2014-3k
WWR-WS721830	Rectangle	72"	18"	30"	231 lbs.	21.36	69" x 15"	CWM-R2020-3K
WWR-WS722418	Rectangle	72"	24"	18"	170 lbs.	16.7	69" x 21"	CWM-R2014-3K
WWR-WS722424	Rectangle	72"	24"	24"	238 lbs.	22	69" x 21"	CWM-R2014-3k
WWR-WS722430	Rectangle	72"	24"	30"	257 lbs.	28.56	69" x 21"	CWM-R2020-3k
WWR-WS722436	Rectangle	72"	24"	36"	291 lbs.	34.49	69" x 21"	CWM-R2020-3k
WWR-WS722442	Rectangle	72"	24"	42"	343 lbs.	40.42	69" x 21"	CWM-R2020-3k
WWR-WS723018	Rectangle	72"	30"	18"	190 lbs.	20.91	69" x 27"	CWM-R2014-3k
WWR-WS723024	Rectangle	72"	30"	24"	226 lbs.	28.34	69" x 27"	CWM-R2020-3k
WWR-WS723030	Rectangle	72"	30"	30"	301 lbs.	35	69" x 27"	CWM-R2020-3k
WWR-WS723036	Rectangle	72"	30"	36"	319 lbs.	43.19	69" x 27"	CWM-R2020-3k
WWR-WS723042	Rectangle	72"	30"	42"	375 lbs.	50.61	69" x 27"	CWM-R2020-3k
WWR-WS723618	Rectangle	72"	36"	18"	210 lbs.	25.12	69" x 33"	CWM-R2014-3k
WWR-WS723624	Rectangle	72"	36"	24"	249 lbs.	34.04	69" x 33"	CWM-R2020-3k

Wilshire Planters Weathering Steel, Rectangle & Square

- 12-gauge A588 and A606 Steel
- Engineered to resist deformation
- Fully welded corners
- Optional toe kick available
- Drain holes standard

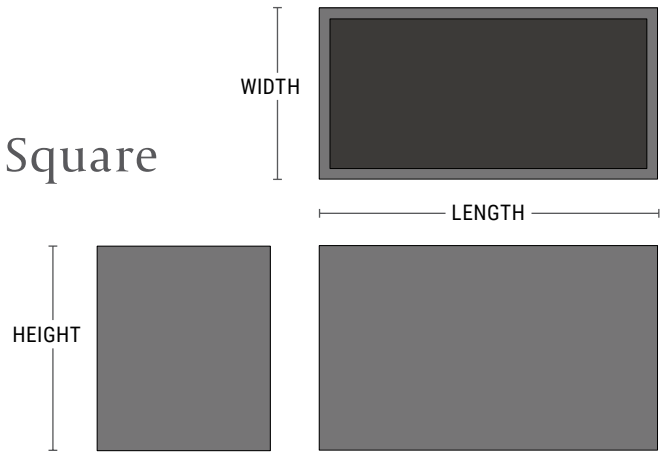

PRODUCT	SHAPE	LENGTH	WIDTH	HEIGHT	WEIGHT (LBS.)	VOLUME (CUBIC FT.)	INTERIOR TOP	IRRIGATION
WWR-WS723630	Rectangle	72"	36"	30"	308 lbs.	42.96	69" x 33"	CWM-R2020-3k
WWR-WS723636	Rectangle	72"	36"	36"	347 lbs.	51.89	69" x 33"	CWM-R2020-3k
WWR-WS723642	Rectangle	72"	36"	42"	406 lbs.	60.81	69" x 33"	CWM-R2020-3k
WWR-WS724818	Rectangle	72"	48"	18"	251 lbs.	33.54	69" x 45"	CWM-R2014-3k
WWR-WS724824	Rectangle	72"	48"	24"	294 lbs.	45.46	69" x 45"	CWM-R2020-3k
WWR-WS724830	Rectangle	72"	48"	30"	360 lbs.	57.37	69" x 45"	CWM-R2020-3k
WWR-WS724836	Rectangle	72"	48"	36"	403 lbs.	69.28	69" x 45"	CWM-R2020-3k
WWR-WS724842	Rectangle	72"	48"	42"	468 lbs.	81.19	69" x 45"	CWM-R2020-3k
WWR-WS7200	Square	72"	72"	30"	566 lbs.	122	69" x 69"	CWM-2920-4KE
WWR-WS961012	Rectangle	96"	10"	12"	121 lbs.	5.91	93" x 7"	CWM-R1109-5k
WWR-WS961218	Rectangle	96"	12"	18"	167 lbs.	11.04	93" x 9"	CWM-R1614-4K
WWR-WS961818	Rectangle	96"	18"	18"	192 lbs.	16.66	93" x 15"	CWM-R2014-3K
WWR-WS961824	Rectangle	96"	18"	24"	267 lbs.	22	93" x 15"	CWM-R2014-4k
WWR-WS961830	Rectangle	96"	18"	30"	317 lbs.	28.5	93" x 15"	CWM-R2020-3K
WWR-WS962418	Rectangle	96"	24"	18"	217 lbs.	22.28	93" x 21"	CWM-R2014-3K
WWR-WS962424	Rectangle	96"	24"	24"	299 lbs.	29.5	93" x 21"	CWM-R2014-4k
WWR-WS962430	Rectangle	96"	24"	30"	348 lbs.	38.11	93" x 21"	CWM-R2020-4k
WWR-WS962436	Rectangle	96"	24"	36"	391 lbs.	46.02	93" x 21"	CWM-R2020-4k
WWR-WS962442	Rectangle	96"	24"	42"	457 lbs.	53.93	93" x 21"	CWM-R2020-4k
WWR-WS963018	Rectangle	96"	30"	18"	241 lbs.	27.9	93" x 27"	CWM-R2014-4k

Wilshire Planters Weathering Steel, Rectangle & Square

- 12-gauge A588 and A606 Steel
- Engineered to resist deformation
- Fully welded corners
- Optional toe kick available
- Drain holes standard

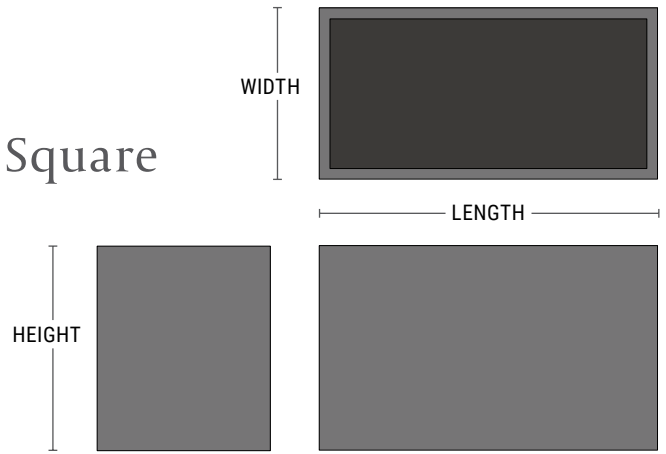

PRODUCT	SHAPE	LENGTH	WIDTH	HEIGHT	WEIGHT (LBS.)	VOLUME (CUBIC FT.)	INTERIOR TOP	IRRIGATION
WWR-WS963024	Rectangle	96"	30"	24"	311 lbs.	37.81	93" x 27"	CWM-R2020-4k
WWR-WS963030	Rectangle	96"	30"	30"	375 lbs.	46.5	93" x 27"	CWM-R2020-4k
WWR-WS963036	Rectangle	96"	30"	36"	425 lbs.	57.62	93" x 27"	CWM-R2020-4k
WWR-WS963042	Rectangle	96"	30"	42"	494 lbs.	67.53	93" x 27"	CWM-R2020-4k
WWR-WS963618	Rectangle	96"	36"	18"	266 lbs.	33.52	93" x 33"	CWM-R2014-4k
WWR-WS963624	Rectangle	96"	36"	24"	338 lbs.	45.42	93" x 33"	CWM-R2020-4k
WWR-WS963630	Rectangle	96"	36"	30"	411 lbs.	57.33	93" x 33"	CWM-R2020-4k
WWR-WS963636	Rectangle	96"	36"	36"	458 lbs.	69.23	93" x 33"	CWM-R2020-4k
WWR-WS963642	Rectangle	96"	36"	42"	531 lbs.	81.14	93" x 33"	CWM-R2020-4k
WWR-WS964818	Rectangle	96"	48"	18"	315 lbs.	44.76	93" x 45"	CWM-R2014-4k
WWR-WS964824	Rectangle	96"	48"	24"	394 lbs.	60.65	93" x 45"	CWM-R2020-4k
WWR-WS964830	Rectangle	96"	48"	30"	474 lbs.	76.55	93" x 45"	CWM-R2020-4k
WWR-WS964836	Rectangle	96"	48"	36"	525 lbs.	92.44	93" x 45"	CWM-R2020-4k
WWR-WS964842	Rectangle	96"	48"	42"	604 lbs.	108.34	93" x 45"	CWM-R2020-4k