



Wilshire Planters

Bring life to your commercial landscape projects with Wilshire, our most popular spacemaking planter collection. Versatility, durability, and customizability set it apart—it's why the landscape architecture community specifies Wilshire on many projects. Available in round, square, and rectangular shapes, as well as with laser cut panels, or Greenscreen®

trellis. Wilshire planters are available in powder-coated aluminum, weathering steel, lightweight GFRC, and FRP fiberglass.

Shown above clockwise: Wilshire Planters with Accessory Pockets, Wilshire Planters in Weathering Steel, Wilshire Hanging Box in FRP, and Wilshire GFRC.

Wilshire Planters

GFRC Wilshire Planters

Lightweight GFRC weighs 75% less than typical cast concrete, but retains its durability, strength, and natural appearance. Wilshire planters in GFRC are great for high traffic, street level installations, but light enough to work on a roof deck. Available in 11 colors and five textures.

- GFRC Rectangle & Square
- GFRC Round
- GFRC Square with Toe Kick
- GFRC Round with Toe Kick
- GFRC with Greenscreen® Trellis
- GFRC with Laser-Cut Screen

FRP Wilshire Planters

The addition of glass fibers turns ordinary resin into a superhero! The Wilshire Planters made from FRP are the lightest among the collection yet can retain moisture-laden soil without deforming. Surface-applied textures add scratch-resistance and are available in stock or custom colors. Available in 18 colors and three textures.

- FRP Rectangle & Square
- FRP Round
- FRP Square with Toe Kick
- FRP Round with Toe Kick
- FRP with Greenscreen® Trellis
- FRP with Laser-Cut Screen
- FRP Hanging Box

METAL Wilshire Planters

Wilshire Powder-Coated Aluminum Planters are an environmentally friendly option. Welded stiffeners are used to produce planters with the strength of steel but 40-60% of the weight.

Wilshire Weathering Steel Planters are shipped with a natural mill-scale or Pre-Weathered finish. Weathering Steel develops a reddish-brown color over time, and Pre-Weathered Steel steps up the oxidation timeline for faster results.

- Aluminum Rectangle & Square
- Aluminum Round
- Aluminum Round with Toe Kick
- Weathering Steel Rectangle & Square
- Weathering Steel Round
- Weathering Steel Round with Toe Kick



Wilshire Planters GFRC Rectangle & Square

Lightweight GFRC weighs 75% less than typical cast concrete, but retains its durability, strength, and natural appearance. Wilshire planters in GFRC are great for high traffic, street level installations, but light enough to work on a roof deck. Available in 11 colors and five textures.

Made in Glass Fiber Reinforced Concrete (GFRC), Wilshire planters are durable in all climates and lighter than standard concrete.

Wilshire Planters, GFRC Rectangle & Square

WILSHIRE PLANTERS, GFRC RECTANGLES & SQUARES

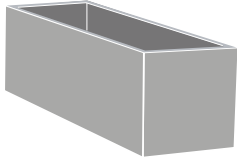

Rectangle

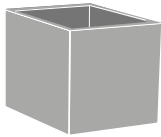

Square

THE COMPLETE WILSHIRE COLLECTION

For additional shapes and materials, visit tournesol.com/collections/wilshire

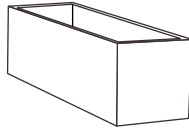

Rectangle

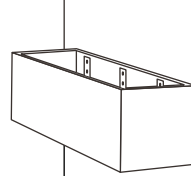

Hanging Box

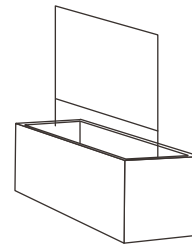

Trellis, Laser-Cut Screen

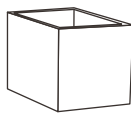

Square

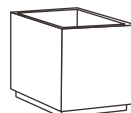

Toe Kick

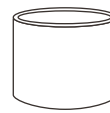

Round



Round with Toe Kick

OPTIONS

Standard Wilshire Planters can be modified with a broad array of options without incurring custom charges. Options are limited to those products that can support them. Speak to a Tournesol Advisor to discuss which options will work with your project.



Irrigation



Change Dimension



Accessory Pockets



Scoops



Casters



Tourneseal



Drain Holes



Matching Saucer



Lift Channels

Wilshire Planters GFRC Rectangle & Square

- Durable Glass Fiber Reinforced Concrete
- 75% lighter than cast concrete
- Huge range of sizes
- Drain holes standard

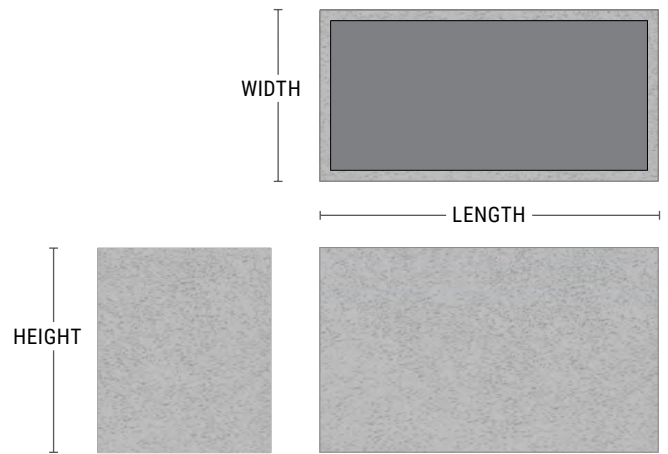

| PRODUCT | SHAPE | LENGTH | WIDTH | HEIGHT | WEIGHT (LBS.) | VOLUME (CUBIC FT.) | INTERIOR TOP | INTERIOR BOTTOM | IRRIGATION |
|------------|-----------|--------|-------|--------|---------------|--------------------|--------------|-----------------|------------------------|
| WCR-241218 | Rectangle | 24" | 12" | 18" | 110 | 2.1 | 20" x 8" | 22.5" x 10.5" | CWM-R1109-MS |
| WCR-241818 | Rectangle | 24" | 18" | 18" | 135 | 3.4 | 20" x 14" | 22.5" x 16.5" | CWM-R1109-MS |
| WCR-241824 | Rectangle | 24" | 18" | 24" | 160 | 4.7 | 20" x 14" | 22.5" x 16.5" | CWM-R1614-MS |
| WCR-241830 | Rectangle | 24" | 18" | 30" | 190 | 6 | 20" x 14" | 22.5" x 16.5" | CWM-R1620-MS |
| WCR-241836 | Rectangle | 24" | 18" | 36" | 190 | 7.3 | 21" x 15" | 22.5" x 16.5" | CWM-R1620-MS |
| WCR-242418 | Square | 24" | 24" | 18" | 155 | 4.7 | 20" x 20" | 22.5" x 22.5" | CWM-R1109-MS |
| WCR-2400F | Square | 24" | 24" | 24" | 225 | 7 | 21" x 21" | 19.5" x 19.5" | CWC-R1850/CWM-R1114-2k |
| WCR-3000F | Square | 30" | 30" | 27" | 275 | 11 | 26" x 26" | 24.5" x 24.5" | CWM-R1620-2k |
| WCR-361218 | Rectangle | 36" | 12" | 18" | 150 | 3.3 | 32" x 8" | 34.5" x 10.5" | CWM-R1109-2k |
| WCR-361818 | Rectangle | 36" | 18" | 18" | 175 | 5.3 | 32" x 14" | 34.5" x 16.5" | CWM-R1109-2k |
| WCR-361824 | Rectangle | 36" | 18" | 24" | 225 | 7.1 | 32" x 14" | 34.5" x 16.5" | CWM-R2014-MS |
| WCR-361830 | Rectangle | 36" | 18" | 30" | 260 | 9.1 | 32" x 14" | 34.5" x 16.5" | CWM-R2020-MS |
| WCR-361836 | Rectangle | 36" | 18" | 36" | 275 | 11.1 | 33" x 15" | 34.5" x 16.5" | CWM-R1620-MS |
| WCR-362418 | Rectangle | 36" | 24" | 18" | 205 | 7.2 | 32" x 20" | 34.5" x 22.5" | CWM-R1109-2k |
| WCR-362424 | Rectangle | 36" | 24" | 24" | 260 | 9.8 | 32" x 20" | 34.5" x 22.5" | CWM-R2014-MS |
| WCR-362430 | Rectangle | 36" | 24" | 30" | 300 | 12.5 | 32" x 20" | 34.5" x 22.5" | CWM-R2920-MS |
| WCR-362436 | Rectangle | 36" | 24" | 36" | 375 | 14.9 | 31" x 19" | 34.5" x 22.5" | CWM-R2020-MS |
| WCR-362442 | Rectangle | 36" | 24" | 42" | 425 | 17.6 | 31" x 19" | 34.5" x 22.5" | CWM-R2020-MS |
| WCR-363018 | Rectangle | 36" | 30" | 18" | 235 | 9.2 | 32" x 26" | 34.5" x 28.5" | CWM-R1109-2k |
| WCR-363024 | Rectangle | 36" | 30" | 24" | 290 | 12.5 | 32" x 26" | 34.5" x 28.5" | CWM-R2914-MS |

Wilshire Planters GFRC Rectangle & Square

- Durable Glass Fiber Reinforced Concrete
- 75% lighter than cast concrete
- Huge range of sizes
- Drain holes standard

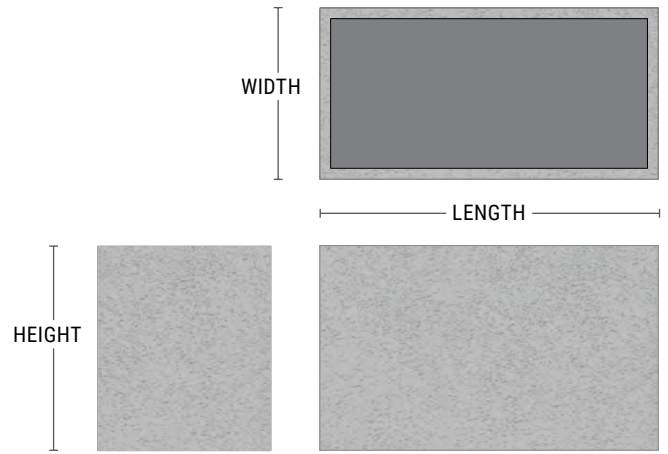

| PRODUCT | SHAPE | LENGTH | WIDTH | HEIGHT | WEIGHT (LBS.) | VOLUME (CUBIC FT.) | INTERIOR TOP | INTERIOR BOTTOM | IRRIGATION |
|------------|-----------|--------|-------|--------|---------------|--------------------|--------------|-----------------|------------------|
| WCR-363030 | Rectangle | 36" | 30" | 30" | 375 | 15.6 | 31" x 25" | 34.5" x 28.5" | CWM-R2920-MS |
| WCR-363042 | Rectangle | 36" | 30" | 42" | 475 | 22.4 | 31" x 25" | 34.5" x 28.5" | CWM-R2920-MS |
| WCR-363618 | Square | 36" | 36" | 18" | 260 | 11.2 | 31" x 31" | 34.5" x 34.5" | CWM-R1109-2k |
| WCR-363624 | Square | 36" | 36" | 24" | 335 | 15.1 | 31" x 31" | 34.5" x 34.5" | CWM-R2914-MS |
| WCR-3600F | Square | 36" | 36" | 30" | 430 | 21 | 31" x 31" | 30.5" x 30.5" | CWM-R2020-2k |
| WCR-363636 | Rectangle | 36" | 36" | 36" | 485 | 23 | 31" x 31" | 34.5" x 34.5" | CWM-R2920-MS |
| WCR-363642 | Rectangle | 36" | 36" | 42" | 530 | 27.1 | 31" x 31" | 34.5" x 34.5" | CWM-R2920-MS |
| WCR-4200F | Square | 42" | 42" | 36" | 580 | 30.7 | 37" x 37" | 40.5" x 40.5" | CWM-R2020-4K-CRT |
| WCR-481218 | Rectangle | 48" | 12" | 18" | 190 | 4.5 | 44" x 8" | 46.5" x 10.5" | CWM-R1109-2k |
| WCR-481818 | Rectangle | 48" | 18" | 18" | 220 | 7.1 | 44" x 14" | 46.5" x 16.5" | CWM-R1109-2k |
| WCR-481824 | Rectangle | 48" | 18" | 24" | 285 | 9.7 | 44" x 14" | 46.5" x 16.5" | CWM-R1614-2k |
| WCR-481830 | Rectangle | 48" | 18" | 30" | 325 | 12.3 | 44" x 14" | 46.5" x 16.5" | CWM-R1620-2k |
| WCR-481836 | Rectangle | 48" | 18" | 36" | 340 | 15 | 45" x 15" | 46.5" x 16.5" | CWM-R1620-2k |
| WCR-482418 | Rectangle | 48" | 24" | 18" | 255 | 9.8 | 44" x 20" | 46.5" x 22.5" | CWM-R1109-3k |
| WCR-482424 | Rectangle | 48" | 24" | 24" | 320 | 13.3 | 44" x 20" | 46.5" x 22.5" | CWM-R1614-2k |
| WCR-482430 | Rectangle | 48" | 24" | 30" | 365 | 16.9 | 44" x 20" | 46.5" x 22.5" | CWM-R1620-2k |
| WCR-482436 | Rectangle | 48" | 24" | 36" | 460 | 20.2 | 43" x 19" | 46.5" x 22.5" | CWM-R1620-2k |
| WCR-482442 | Rectangle | 48" | 24" | 42" | 515 | 23.8 | 43" x 19" | 46.5" x 22.5" | CWM-R1620-2k |
| WCR-483018 | Rectangle | 48" | 30" | 18" | 285 | 12.5 | 44" x 26" | 46.5" x 28.5" | CWM-R1109-2k |
| WCR-483024 | Rectangle | 48" | 30" | 24" | 355 | 16.9 | 44" x 26" | 46.5" x 28.5" | CWM-R1614-2k |

Wilshire Planters GFRC Rectangle & Square

- Durable Glass Fiber Reinforced Concrete
- 75% lighter than cast concrete
- Huge range of sizes
- Drain holes standard

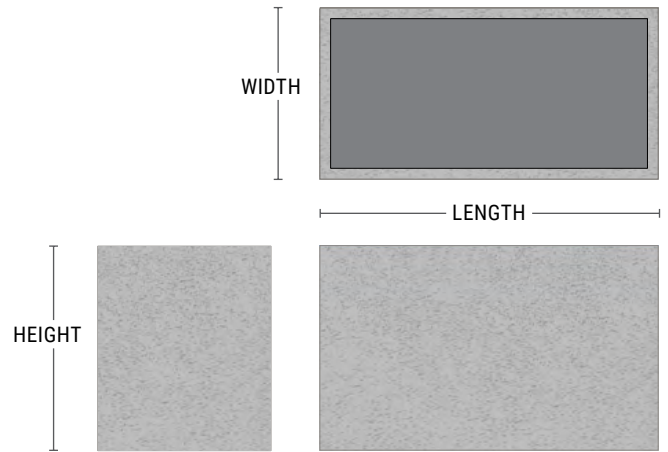

| PRODUCT | SHAPE | LENGTH | WIDTH | HEIGHT | WEIGHT (LBS.) | VOLUME (CUBIC FT.) | INTERIOR TOP | INTERIOR BOTTOM | IRRIGATION |
|------------|-----------|--------|-------|--------|---------------|--------------------|--------------|-----------------|--------------|
| WCR-483030 | Rectangle | 48" | 30" | 30" | 455 | 21.2 | 43" x 25" | 46.5" x 28.5" | CWM-R1620-2k |
| WCR-483036 | Rectangle | 48" | 30" | 36" | 515 | 25.7 | 43" x 25" | 46.5" x 28.5" | CWM-R1620-2k |
| WCR-483042 | Rectangle | 48" | 30" | 42" | 570 | 30.3 | 43" x 25" | 46.5" x 28.5" | CWM-R1620-2k |
| WCR-483618 | Rectangle | 48" | 36" | 18" | 320 | 15.1 | 43" x 31" | 46.5" x 34.5" | CWM-R1109-2k |
| WCR-483624 | Rectangle | 48" | 36" | 24" | 405 | 20.5 | 43" x 31" | 46.5" x 34.5" | CWM-R1614-2k |
| WCR-483630 | Rectangle | 48" | 36" | 30" | 460 | 26.1 | 43" x 31" | 46.5" x 34.5" | CWM-R1620-2k |
| WCR-483636 | Rectangle | 48" | 36" | 36" | 575 | 31.2 | 43" x 31" | 46.5" x 34.5" | CWM-R1620-2k |
| WCR-483642 | Rectangle | 48" | 36" | 42" | 630 | 36.8 | 43" x 31" | 46.5" x 34.5" | CWM-R1620-2k |
| WCR-484818 | Square | 48" | 48" | 18" | 400 | 18.7 | 43" x 43" | 46.5" x 46.5" | CWM-R1614-2k |
| WCR-4824F | Square | 48" | 48" | 24" | 500 | 26.5 | 43" x 43" | 42.5" x 42.5" | CWM-R2914-2k |
| WCR-484830 | Square | 48" | 48" | 30" | 560 | 33.2 | 43" x 43" | 46.5" x 46.5" | CWM-R1620-2k |
| WCR-4800F | Square | 48" | 48" | 36" | 700 | 45 | 43" x 43" | 42.5" x 42.5" | CWM-R2920-2k |
| WCR-484842 | Square | 48" | 48" | 42" | 870 | 46.8 | 43" x 43" | 46.5" x 46.5" | CWM-R1620-2k |
| WCR-601218 | Rectangle | 60" | 12" | 18" | 230 | 5.6 | 56" x 8" | 58.5" x 10.5" | CWM-R1109-3k |
| WCR-601818 | Rectangle | 60" | 18" | 18" | 270 | 8.9 | 56" x 14" | 58.5" x 16.5" | CWM-R1109-3k |
| WCR-601824 | Rectangle | 60" | 18" | 24" | 345 | 12.1 | 56" x 14" | 58.5" x 16.5" | CWM-R2014-2k |
| WCR-601830 | Rectangle | 60" | 18" | 30" | 400 | 15.5 | 56" x 14" | 58.5" x 16.5" | CWM-R2020-2k |
| WCR-601836 | Rectangle | 60" | 18" | 36" | 425 | 18.7 | 57" x 15" | 58.5" x 16.5" | CWM-R2020-2k |
| WCR-602418 | Rectangle | 60" | 24" | 18" | 305 | 12.3 | 56" x 20" | 58.5" x 22.5" | CWM-R1109-3k |
| WCR-602424 | Rectangle | 60" | 24" | 24" | 385 | 16.7 | 56" x 20" | 58.5" x 22.5" | CWM-R2014-2k |

Wilshire Planters GFRC Rectangle & Square

- Durable Glass Fiber Reinforced Concrete
- 75% lighter than cast concrete
- Huge range of sizes
- Drain holes standard

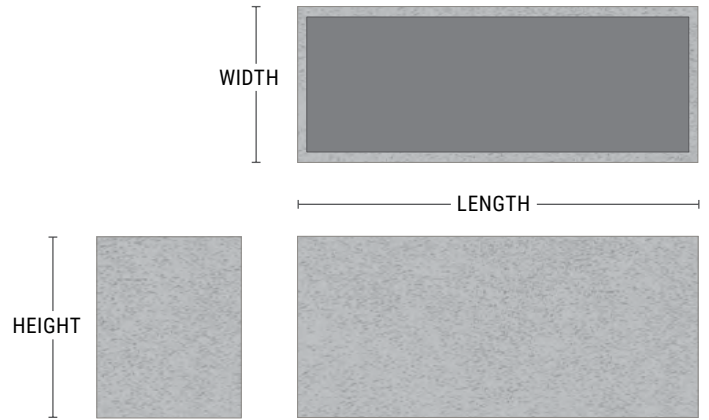

| PRODUCT | SHAPE | LENGTH | WIDTH | HEIGHT | WEIGHT (LBS.) | VOLUME (CUBIC FT.) | INTERIOR TOP | INTERIOR BOTTOM | IRRIGATION |
|------------|-----------|--------|-------|--------|---------------|--------------------|--------------|-----------------|--------------|
| WCR-602430 | Rectangle | 60" | 24" | 30" | 445 | 21.3 | 56" x 20" | 58.5" x 22.5" | CWM-R2020-2k |
| WCR-602436 | Rectangle | 60" | 24" | 36" | 565 | 25.4 | 55" x 19" | 58.5" x 22.5" | CWM-R2020-2k |
| WCR-602442 | Rectangle | 60" | 24" | 42" | 630 | 29.9 | 55" x 19" | 58.5" x 22.5" | CWM-R2020-2k |
| WCR-603018 | Rectangle | 60" | 30" | 18" | 345 | 15.7 | 56" x 26" | 58.5" x 28.5" | CWM-R1109-3k |
| WCR-603024 | Rectangle | 60" | 30" | 24" | 425 | 21.3 | 56" x 26" | 58.5" x 28.5" | CWM-R2014-2k |
| WCR-603030 | Rectangle | 60" | 30" | 30" | 545 | 26.7 | 55" x 25" | 58.5" x 28.5" | CWM-R2020-2k |
| WCR-603042 | Rectangle | 60" | 30" | 42" | 690 | 38.1 | 55" x 25" | 58.5" x 28.5" | CWM-R2020-2k |
| WCR-603618 | Rectangle | 60" | 36" | 18" | 380 | 19.1 | 55" x 31" | 58.5" x 34.5" | CWM-R1109-3k |
| WCR-603624 | Rectangle | 60" | 36" | 24" | 480 | 25.8 | 55" x 31" | 58.5" x 34.5" | CWM-R2014-2k |
| WCR-603630 | Rectangle | 60" | 36" | 30" | 545 | 32.8 | 55" x 31" | 58.5" x 34.5" | CWM-R2020-2k |
| WCR-603636 | Rectangle | 60" | 36" | 36" | 690 | 39.2 | 55" x 31" | 58.5" x 34.5" | CWM-R2020-2k |
| WCR-603642 | Rectangle | 60" | 36" | 42" | 755 | 46.2 | 55" x 31" | 58.5" x 34.5" | CWM-R2020-2k |
| WCR-604818 | Rectangle | 60" | 48" | 18" | 470 | 23.5 | 55" x 43" | 58.5" x 46.5" | CWM-R2014-2k |
| WCR-604824 | Rectangle | 60" | 48" | 24" | 780 | 32.4 | 55" x 43" | 58.5" x 46.5" | CWM-R2014-2k |
| WCR-604830 | Rectangle | 60" | 48" | 30" | 655 | 41.8 | 55" x 43" | 58.5" x 46.5" | CWM-R2020-2k |
| WCR-604836 | Rectangle | 60" | 48" | 36" | 930 | 49.5 | 55" x 43" | 58.5" x 46.5" | CWM-R2020-2k |
| WCR-604842 | Rectangle | 60" | 48" | 42" | 1035 | 58.7 | 55" x 43" | 58.5" x 46.5" | CWM-R2020-2k |
| WCR-6000F | Square | 60" | 60" | 42" | 1050 | 51 | 55" x 55" | 54.5" x 54.5" | CWM-R2920-4k |
| WCR-721218 | Rectangle | 72" | 12" | 18" | 270 | 6.8 | 68" x 8" | 70.5" x 10.5" | CWM-R1109-4k |
| WCR-721818 | Rectangle | 72" | 18" | 18" | 315 | 10.8 | 68" x 14" | 70.5" x 16.5" | CWM-R1109-4k |

Wilshire Planters GFRC Rectangle & Square

- Durable Glass Fiber Reinforced Concrete
- 75% lighter than cast concrete
- Huge range of sizes
- Drain holes standard

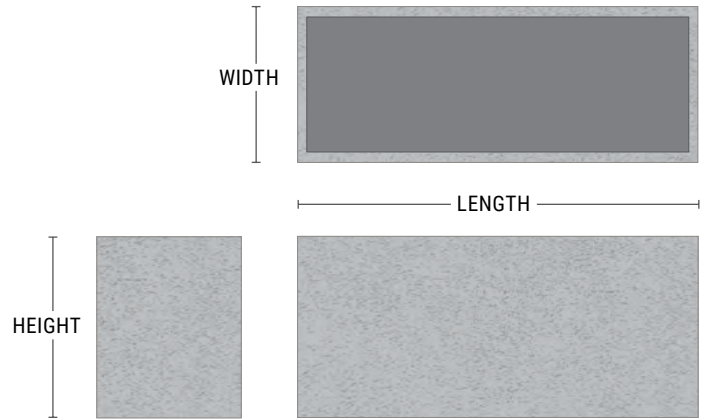

| PRODUCT | SHAPE | LENGTH | WIDTH | HEIGHT | WEIGHT (LBS.) | VOLUME (CUBIC FT.) | INTERIOR TOP | INTERIOR BOTTOM | IRRIGATION |
|------------|-----------|--------|-------|--------|---------------|--------------------|--------------|-----------------|--------------|
| WCR-721824 | Rectangle | 72" | 18" | 24" | 410 | 14.6 | 68" x 14" | 70.5" x 16.5" | CWM-R1614-3k |
| WCR-721830 | Rectangle | 72" | 18" | 30" | 470 | 18.6 | 68" x 14" | 70.5" x 16.5" | CWM-R1620-3k |
| WCR-721836 | Rectangle | 72" | 18" | 36" | 500 | 22.5 | 69" x 15" | 70.5" x 16.5" | CWM-R1620-3k |
| WCR-722418 | Rectangle | 72" | 24" | 18" | 360 | 14.8 | 68" x 20" | 70.5" x 22.5" | CWM-R1109-4k |
| WCR-722424 | Rectangle | 72" | 24" | 24" | 450 | 20.1 | 68" x 20" | 70.5" x 22.5" | CWM-R1614-3k |
| WCR-722430 | Rectangle | 72" | 24" | 30" | 520 | 25.6 | 68" x 20" | 70.5" x 22.5" | CWM-R1620-3k |
| WCR-722436 | Rectangle | 72" | 24" | 36" | 660 | 30.6 | 67" x 19" | 70.5" x 22.5" | CWM-R1620-3k |
| WCR-722442 | Rectangle | 72" | 24" | 42" | 735 | 36 | 67" x 19" | 70.5" x 22.5" | CWM-R1620-3k |
| WCR-723018 | Rectangle | 72" | 30" | 18" | 400 | 18.9 | 68" x 26" | 70.5" x 28.5" | CWM-R1109-4k |
| WCR-723024 | Rectangle | 72" | 30" | 24" | 500 | 25.7 | 68" x 26" | 70.5" x 28.5" | CWM-R1614-3k |
| WCR-723030 | Rectangle | 72" | 30" | 30" | 630 | 32.2 | 67" x 25" | 70.5" x 28.5" | CWM-R1620-3k |
| WCR-723036 | Rectangle | 72" | 30" | 36" | 725 | 38.9 | 67" x 25" | 70.5" x 28.5" | CWM-R1620-3k |
| WCR-723042 | Rectangle | 72" | 30" | 42" | 795 | 45.9 | 67" x 25" | 70.5" x 28.5" | CWM-R1620-3k |
| WCR-723618 | Rectangle | 72" | 36" | 18" | 440 | 23 | 67" x 31" | 70.5" x 34.5" | CWM-R1109-4k |
| WCR-723624 | Rectangle | 72" | 36" | 24" | 550 | 31.1 | 67" x 31" | 70.5" x 34.5" | CWM-R1614-3k |
| WCR-723630 | Rectangle | 72" | 36" | 30" | 625 | 39.5 | 67" x 31" | 70.5" x 34.5" | CWM-R1620-3k |
| WCR-723636 | Rectangle | 72" | 36" | 36" | 795 | 47.3 | 67" x 31" | 70.5" x 34.5" | CWM-R1620-3k |
| WCR-723642 | Rectangle | 72" | 36" | 42" | 870 | 55.7 | 67" x 31" | 70.5" x 34.5" | CWM-R1620-3k |
| WCR-724818 | Rectangle | 72" | 48" | 18" | 540 | 28.3 | 67" x 43" | 70.5" x 46.5" | CWM-R1614-3k |
| WCR-724824 | Rectangle | 72" | 48" | 24" | 995 | 39.1 | 67" x 43" | 70.5" x 46.5" | CWM-R2914-2k |

Wilshire Planters GFRC Rectangle & Square

- Durable Glass Fiber Reinforced Concrete
- 75% lighter than cast concrete
- Huge range of sizes
- Drain holes standard

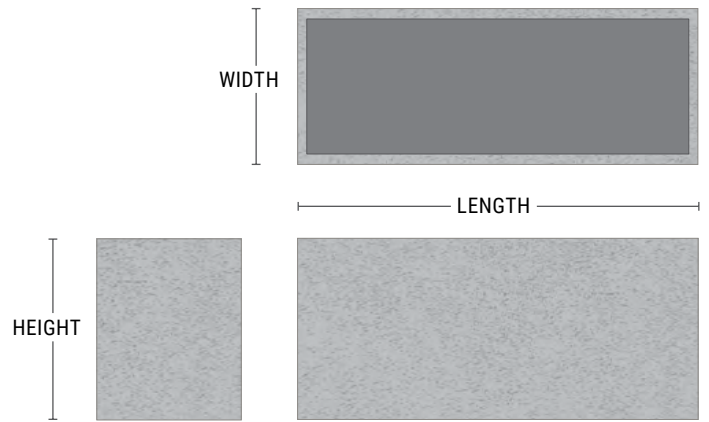

| PRODUCT | SHAPE | LENGTH | WIDTH | HEIGHT | WEIGHT (LBS.) | VOLUME (CUBIC FT.) | INTERIOR TOP | INTERIOR BOTTOM | IRRIGATION |
|------------|-----------|--------|-------|--------|---------------|--------------------|--------------|-----------------|----------------|
| WCR-724830 | Rectangle | 72" | 48" | 30" | 750 | 50.5 | 67" x 43" | 70.5" x 46.5" | CWM-R1620-3k |
| WCR-724836 | Rectangle | 72" | 48" | 36" | 1060 | 59.8 | 67" x 43" | 70.5" x 46.5" | CWM-R2920-2k |
| WCR-724842 | Rectangle | 72" | 48" | 42" | 1165 | 71 | 67" x 43" | 70.5" x 46.5" | CWM-R2920-2k |
| WCR-7200F | Square | 72" | 72" | 42" | 1250 | 112.5 | 67" x 67" | 66.5" x 66.5" | CWM-R2020-4k-E |
| WCR-961218 | Rectangle | 96" | 12" | 18" | 350 | 9.1 | 92" x 8" | 94.5" x 10.5" | CWM-R1109-4k |
| WCR-961818 | Rectangle | 96" | 18" | 18" | 445 | 14.2 | 92" x 14" | 94.5" x 16.5" | CWM-R1109-5k |
| WCR-961824 | Rectangle | 96" | 18" | 24" | 555 | 19.3 | 92" x 14" | 94.5" x 16.5" | CWM-R1614-3k |
| WCR-961830 | Rectangle | 96" | 18" | 30" | 635 | 24.7 | 92" x 14" | 94.5" x 16.5" | CWM-R2020-3k |
| WCR-961836 | Rectangle | 96" | 18" | 36" | 640 | 30.2 | 93" x 15" | 94.5" x 16.5" | CWM-R1620-4k |
| WCR-962418 | Rectangle | 96" | 24" | 18" | 490 | 19.7 | 92" x 20" | 94.5" x 22.5" | CWM-R1109-5k |
| WCR-962424 | Rectangle | 96" | 24" | 24" | 575 | 27 | 92" x 20" | 94.5" x 22.5" | CWM-R2014-3k |
| WCR-962430 | Rectangle | 96" | 24" | 30" | 700 | 34.1 | 92" x 20" | 94.5" x 22.5" | CWM-R1620-4k |
| WCR-962436 | Rectangle | 96" | 24" | 36" | 885 | 40.7 | 91" x 19" | 94.5" x 22.5" | CWM-R1620-4k |
| WCR-962442 | Rectangle | 96" | 24" | 42" | 965 | 48.1 | 91" x 19" | 94.5" x 22.5" | CWM-R2020-3k |
| WCR-963018 | Rectangle | 96" | 30" | 18" | 540 | 25.2 | 92" x 26" | 94.5" x 28.5" | CWM-R1109-5k |
| WCR-963024 | Rectangle | 96" | 30" | 24" | 665 | 34.2 | 92" x 26" | 94.5" x 28.5" | CWM-R2014-3k |
| WCR-963030 | Rectangle | 96" | 30" | 30" | 825 | 43 | 91" x 25" | 94.5" x 28.5" | CWM-R2020-3k |
| WCR-963036 | Rectangle | 96" | 30" | 36" | 935 | 51 | 91" x 25" | 94.5" x 28.5" | CWM-R2020-3k |
| WCR-963042 | Rectangle | 96" | 30" | 42" | 1045 | 61.3 | 91" x 25" | 94.5" x 28.5" | CWM-R1620-4k |
| WCR-963618 | Rectangle | 96" | 36" | 18" | 585 | 30.6 | 91" x 31" | 94.5" x 34.5" | CWM-R1109-5k |

Wilshire Planters GFRC Rectangle & Square

- Durable Glass Fiber Reinforced Concrete
- 75% lighter than cast concrete
- Huge range of sizes
- Drain holes standard

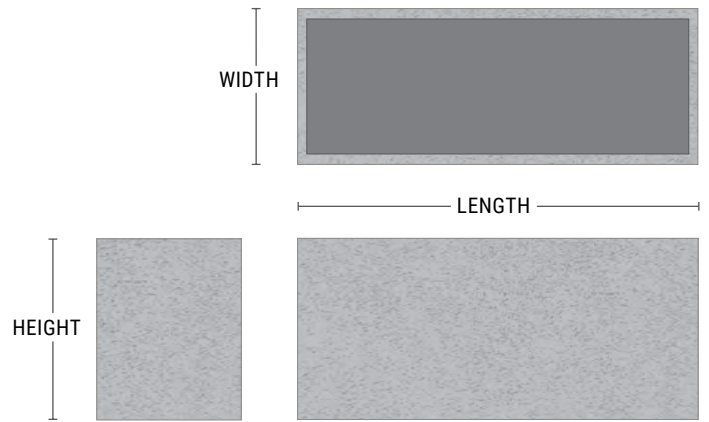

| PRODUCT | SHAPE | LENGTH | WIDTH | HEIGHT | WEIGHT (LBS.) | VOLUME (CUBIC FT.) | INTERIOR TOP | INTERIOR BOTTOM | IRRIGATION |
|-------------|-----------|--------|-------|--------|---------------|--------------------|--------------|-----------------|------------------------------------|
| WCR-963624 | Rectangle | 96" | 36" | 24" | 725 | 41.6 | 91" x 31" | 94.5" x 34.5" | CWM-R2014-3k |
| WCR-963630 | Rectangle | 96" | 36" | 30" | 820 | 52.9 | 91" x 31" | 94.5" x 34.5" | CWM-R2020-3k |
| WCR-963636 | Rectangle | 96" | 36" | 36" | 995 | 63.5 | 91" x 31" | 94.5" x 34.5" | CWM-R1620-4k |
| WCR-963642 | Rectangle | 96" | 36" | 42" | 1115 | 74.6 | 91" x 31" | 94.5" x 34.5" | CWM-R1620-4k |
| WCR-964818 | Rectangle | 96" | 48" | 18" | 710 | 37.6 | 91" x 43" | 94.5" x 46.5" | CWM-R2014-3k |
| WCR-964824 | Rectangle | 96" | 48" | 24" | 865 | 52.1 | 91" x 43" | 94.5" x 46.5" | CWM-R2014-3k |
| WCR-964830 | Rectangle | 96" | 48" | 30" | 960 | 67.3 | 91" x 43" | 94.5" x 46.5" | CWM-R2020-3k |
| WCR-964836 | Rectangle | 96" | 48" | 36" | 1320 | 80.5 | 91" x 43" | 94.5" x 46.5" | CWM-R2020-4k |
| WCR-964842 | Rectangle | 96" | 48" | 42" | 1480 | 95 | 91" x 43" | 94.5" x 46.5" | CWM-R2020-4k |
| WCR-1201218 | Rectangle | 120" | 12" | 18" | 430 | 11.4 | 116" x 8" | 118.5" x 10.5" | CWM-R1109-5k or CWM R1109-MS |
| WCR-1201818 | Rectangle | 120" | 18" | 18" | 545 | 17.8 | 116" x 14" | 118.5" x 16.5" | CWM-R1114-4k/5K or CWM-R1614-4k/5k |
| WCR-1201824 | Rectangle | 120" | 18" | 24" | 685 | 24.3 | 116" x 14" | 118.5" x 16.5" | CWM-R1614-4k |
| WCR-1201830 | Rectangle | 120" | 18" | 30" | 780 | 31 | 116" x 14" | 118.5" x 16.5" | CWM-R2020-4k |
| WCR-1201836 | Rectangle | 120" | 18" | 36" | 835 | 37.5 | 117" x 15" | 118.5" x 16.5" | CWM-R1620-4k |
| WCR-1202418 | Rectangle | 120" | 24" | 18" | 600 | 24.7 | 116" x 20" | 118.5" x 22.5" | CWM-R1109-5K or CWM-R1109-MS |
| WCR-1202424 | Rectangle | 120" | 24" | 24" | 705 | 33.9 | 116" x 20" | 118.5" x 22.5" | CWM-R2014-4k |
| WCR-1202430 | Rectangle | 120" | 24" | 30" | 845 | 42.8 | 116" x 20" | 118.5" x 22.5" | CWM-R2020-4k |
| WCR-1202436 | Rectangle | 120" | 24" | 36" | 1070 | 51.1 | 115" x 19" | 118.5" x 22.5" | CWM-R2020-4k |
| WCR-1202442 | Rectangle | 120" | 24" | 42" | 1175 | 60.3 | 115" x 19" | 118.5" x 22.5" | CWM-R2020-4k |
| WCR-1203018 | Rectangle | 120" | 30" | 18" | 660 | 31.6 | 116" x 26" | 118.5" x 28.5" | CWM-R1109-3K or CWM-R1109-4K |

Wilshire Planters GFRC Rectangle & Square

- Durable Glass Fiber Reinforced Concrete
- 75% lighter than cast concrete
- Huge range of sizes
- Drain holes standard

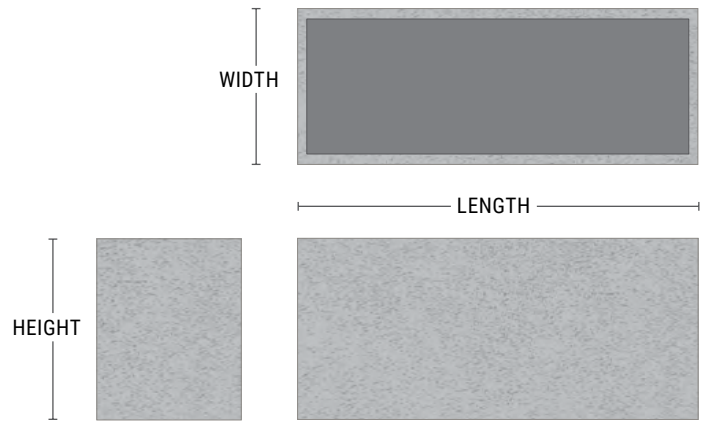

| PRODUCT | SHAPE | LENGTH | WIDTH | HEIGHT | WEIGHT (LBS.) | VOLUME (CUBIC FT.) | INTERIOR TOP | INTERIOR BOTTOM | IRRIGATION |
|-------------|-----------|--------|-------|--------|---------------|--------------------|--------------|-----------------|---------------|
| WCR-1203024 | Rectangle | 120" | 30" | 24" | 805 | 42.9 | 116" x 26" | 118.5" x 28.5" | CWM-R2014-4k |
| WCR-1203030 | Rectangle | 120" | 30" | 30" | 1000 | 54 | 115" x 25" | 118.5" x 28.5" | CWM-R2020-4k |
| WCR-1203042 | Rectangle | 120" | 30" | 42" | 1255 | 77 | 115" x 25" | 118.5" x 28.5" | CWM-R2020-4k |
| WCR-1203618 | Rectangle | 120" | 36" | 18" | 710 | 38.5 | 115" x 31" | 118.5" x 34.5" | CWM-R1109-5k |
| WCR-1203624 | Rectangle | 120" | 36" | 24" | 880 | 52.2 | 115" x 31" | 118.5" x 34.5" | CWM-R2014-4K1 |
| WCR-1203630 | Rectangle | 120" | 36" | 30" | 990 | 66.3 | 115" x 31" | 118.5" x 34.5" | CWM-R2020-4k |
| WCR-1203636 | Rectangle | 120" | 36" | 36" | 1235 | 79.5 | 115" x 31" | 118.5" x 34.5" | CWM-R2020-4k |
| WCR-1203642 | Rectangle | 120" | 36" | 42" | 1345 | 93.6 | 115" x 31" | 118.5" x 34.5" | CWM-R2020-4k |



Wilshire Planters GFRC Round

Lightweight GFRC weighs 75% less than typical cast concrete, but retains its durability, strength, and natural appearance. Wilshire planters in GFRC are great for high traffic, street level installations, but light enough to work on a roof deck. Available in 11 colors and five textures.

Made in Glass Fiber Reinforced Concrete (GFRC), Wilshire planters are durable in all climates and lighter than standard concrete.

Wilshire Planters, GFRC Round

WILSHIRE PLANTERS, GFRC ROUND

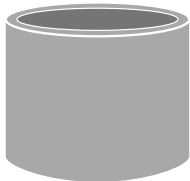

Round

THE COMPLETE WILSHIRE COLLECTION

For additional shapes and materials, visit tournesol.com/collections/wilshire

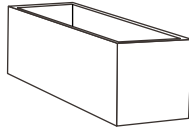

Rectangle

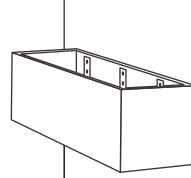

Hanging Box

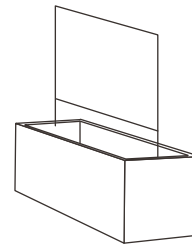

Trellis, Laser-Cut Screen



Square

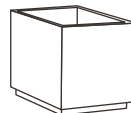

Toe Kick

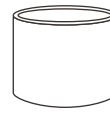

Round



Round with Toe Kick

OPTIONS

Standard Wilshire Planters can be modified with a broad array of options without incurring custom charges. Options are limited to those products that can support them. Speak to a Tournesol Advisor to discuss which options will work with your project.



Irrigation



Change Dimension



Casters



TourneSeal



Drain Holes



Matching Saucer

Wilshire Planters GFRC Round

- Durable Glass Fiber Reinforced Concrete
- Natural stone appearance
- 75% lighter than cast concrete
- Drain holes standard

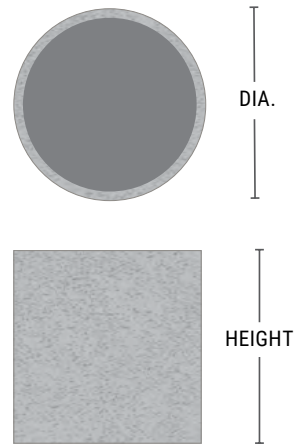

| PRODUCT | SHAPE | DIA. | HEIGHT | WEIGHT (LBS.) | VOLUME (CUBIC FT.) | INTERIOR TOP | INTERIOR BOTTOM | IRRIGATION |
|-----------|-------|---------|--------|---------------|--------------------|--------------|-----------------|----------------------|
| WCS-2400F | Round | 24" dia | 24" | 130 | 5.5 | 21" dia | 19.5" dia | CWC-1600/CWM-1114-2k |
| WCS-3000F | Round | 30" dia | 27" | 185 | 10 | 27" dia | 24.5" dia | CWC-2400/CWM-1720-2k |
| WCS-3600F | Round | 36" dia | 30" | 275 | 16.5 | 31.5" dia | 30.5" dia | CWM-1720-3k |
| WCS-4200F | Round | 42" dia | 33" | 340 | 25 | 37.5" dia | 36.5" dia | CWM-1720-3k |
| WCS-4800F | Round | 48" dia | 36" | 445 | 32.5 | 43.5" dia | 42.5" dia | CWM-2920-3k |
| WCS-6000F | Round | 60" dia | 36" | 590 | 52 | 55.5" dia | 54.5" dia | CWM-2920-4k |
| WCS-7200F | Round | 72" dia | 42" | 865 | 86.5 | 67" dia | 66.5" dia | CWM-2920-4k |



Wilshire Planters GFRC Square with Toe Kick

Lightweight GFRC weighs 75% less than typical cast concrete, but retains its durability, strength, and natural appearance. Wilshire planters in GFRC are great for high traffic, street level installations, but light enough to work on a roof deck. Available in 11 colors and five textures.

Made in Glass Fiber Reinforced Concrete (GFRC), Wilshire planters are durable in all climates and lighter than standard concrete.

Wilshire Planters, GFR Square with Toe Kick

WILSHIRE PLANTERS, GFR SQUARE WITH TOE KICK

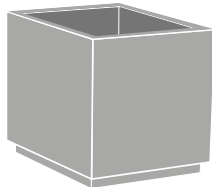

Square with Toe Kick

THE COMPLETE WILSHIRE COLLECTION

For additional shapes and materials, visit tournesol.com/collections/wilshire

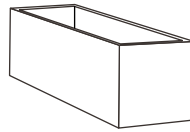

Rectangle

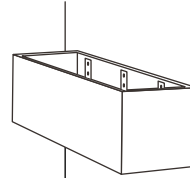

Hanging Box

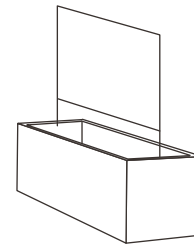

Trellis, Laser-Cut Screen

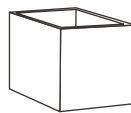

Square

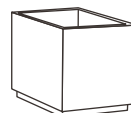

Toe Kick

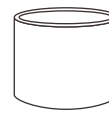

Round



Round with Toe Kick

OPTIONS

Standard Wilshire Planters can be modified with a broad array of options without incurring custom charges. Options are limited to those products that can support them. Speak to a Tournesol Advisor to discuss which options will work with your project.



Irrigation



Change Dimension



Accessory Pockets



Scoops



TourneSeal



Drain Holes



Matching Saucer



Lift Channels

Wilshire Planters GFRC Square with Toe Kick

- Durable Glass Fiber Reinforced Concrete
- 75% lighter than cast concrete
- Standard toe kick
- Toe kick can accommodate lighting
- Drain holes standard

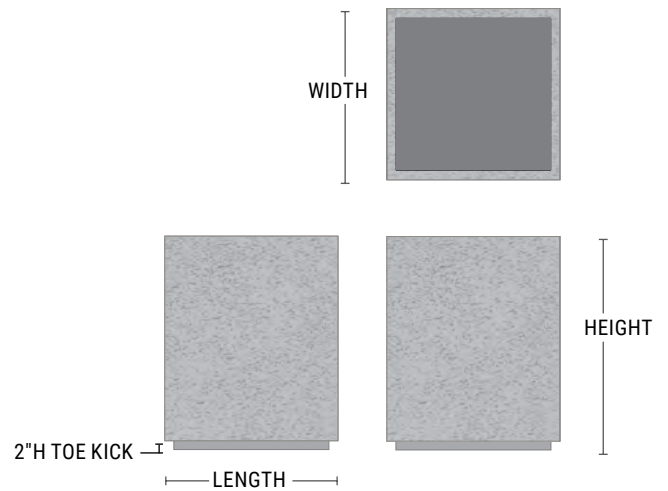

| PRODUCT | SHAPE | LENGTH | WIDTH | HEIGHT | WEIGHT (LBS.) | VOLUME (CUBIC FT.) | INTERIOR TOP | INTERIOR BOTTOM | IRRIGATION |
|-----------|------------------------|--------|-------|--------|---------------|--------------------|--------------|-----------------|------------------------|
| WCRT-1800 | Toe Kick Square - tall | 18" | 18" | 30" | 115 | 5.2 | 15" x 15" | 16.5" x 16.5" | CWC-R1100 |
| WCR-2400 | Toe Kick Square | 24" | 24" | 24" | 225 | 7 | 21" x 21" | 19.5" x 19.5" | CWC-R1850/CWM-R1114-2k |
| WCRT-2400 | Toe Kick Square - tall | 24" | 24" | 48" | 240 | 14.9 | 21" x 21" | 22.5" x 22.5" | CWC-R1850 |
| WCR-3000 | Toe Kick Square | 30" | 30" | 27" | 275 | 11 | 26" x 26" | 24.5" x 24.5" | CWM-R1620-2k |
| WCRT-3000 | Toe Kick Square - tall | 30" | 30" | 54" | 390 | 26.4 | 26" x 26" | 28.5" x 28.5" | CWM-R1620-2k-CRT |
| WCR-3600 | Toe Kick Square | 36" | 36" | 30" | 430 | 21 | 31" x 31" | 30.5" x 30.5" | CWM-R2020-2k |
| WCR-4800 | Toe Kick Square | 48" | 48" | 36" | 700 | 45 | 43" x 43" | 42.5" x 42.5" | CWM-R2920-2k |
| WCR-4824 | Toe Kick Square | 48" | 48" | 24" | 500 | 26.5 | 43" x 43" | 42.5" x 42.5" | CWM-R2914-2k |
| WCR-6000 | Toe Kick Square | 60" | 60" | 42" | 1050 | 51 | 55" x 55" | 54.5" x 54.5" | CWM-R2920-4k |
| WCR-7200 | Toe Kick Square | 72" | 72" | 42" | 1250 | 112.5 | 67" x 67" | 66.5" x 66.5" | CWM-R2020-4k-E |



Wilshire Planters GFRC Round with Toe Kick

Lightweight GFRC weighs 75% less than typical cast concrete, but retains its durability, strength, and natural appearance. Wilshire planters in GFRC are great for high traffic, street level installations, but light enough to work on a roof deck. Available in 11 colors and five textures.

Made in Glass Fiber Reinforced Concrete (GFRC), Wilshire planters are durable in all climates and lighter than standard concrete.

Wilshire Planters, GFRC Round with Toe Kick

WILSHIRE PLANTERS, GFRC ROUND WITH TOE KICK

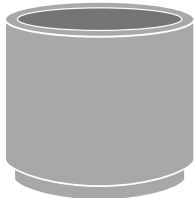

Round with Toe Kick

THE COMPLETE WILSHIRE COLLECTION

For additional shapes and materials, visit tournesol.com/collections/wilshire

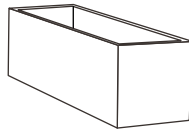

Rectangle

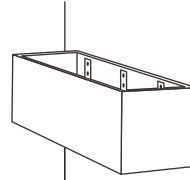

Hanging Box

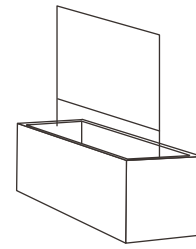

Trellis, Laser-Cut Screen

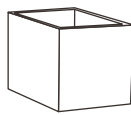

Square

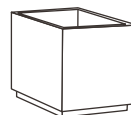

Toe Kick

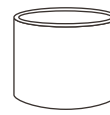

Round

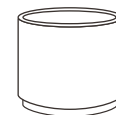

Round with Toe Kick

OPTIONS

Standard Wilshire Planters can be modified with a broad array of options without incurring custom charges. Options are limited to those products that can support them. Speak to a Tournesol Advisor to discuss which options will work with your project.



Irrigation



Change Dimension



TourneSeal



Drain Holes



Matching Saucer

Wilshire Planters GFRC Round with Toe Kick

- Durable Glass Fiber Reinforced Concrete
- 75% lighter than cast concrete
- Toe kick visually lifts planter
- Toe kick can accommodate lighting
- Drain holes standard

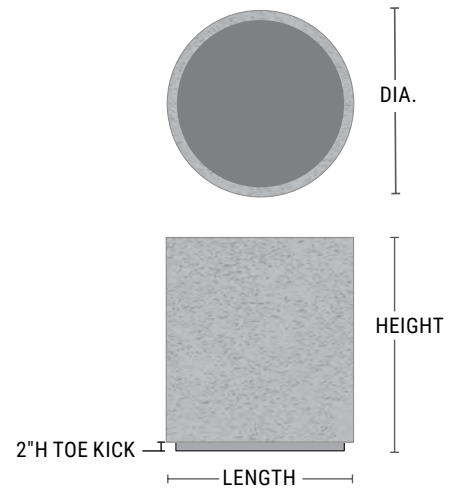

| PRODUCT | SHAPE | DIA. | HEIGHT | WEIGHT (LBS.) | VOLUME (CUBIC FT.) | INTERIOR TOP | INTERIOR BOTTOM | IRRIGATION |
|-----------|-----------------------|---------|--------|---------------|--------------------|--------------|-----------------|----------------------|
| WCST-1800 | Toe Kick Round - Tall | 18" dia | 30" | 95 | 3.5 | 15" x 15" | 16.5" x 16.5" | CWI-1200 |
| WCS-2400 | Toe Kick Round | 24" dia | 24" | 130 | 5.5 | 21" dia | 19.5" dia | CWC-1600/CWM-1114-2k |
| WCST-2400 | Toe Kick Round - Tall | 24" dia | 48" | 190 | 10.6 | 21" x 21" | 22.5" x 22.5" | CWI-1700 |
| WCS-3000 | Toe Kick Round | 30" dia | 27" | 185 | 10 | 27" dia | 24.5" dia | CWC-2400/CWM-1720-2k |
| WCST-3000 | Toe Kick Round - Tall | 30" dia | 54" | 285 | 19.2 | 26" x 26" | 28.5" x 28.5" | CWI-2200 |
| WCS-3600 | Toe Kick Round | 36" dia | 30" | 275 | 16.5 | 31.5" dia | 30.5" dia | CWM-1720-3k |
| WCS-4200 | Toe Kick Round | 42" dia | 33" | 340 | 25 | 37.5" dia | 36.5" dia | CWM-1720-3k |
| WCS-4800 | Toe Kick Round | 48" dia | 36" | 445 | 32.5 | 43.5" dia | 42.5" dia | CWM-2920-3k |
| WCS-6000 | Toe Kick Round | 60" dia | 36" | 590 | 52 | 55.5" dia | 54.5" dia | CWM-2920-4k |
| WCS-7200 | Toe Kick Round | 72" dia | 42" | 865 | 86.5 | 67" dia | 66.5" dia | CWM-2920-4k |



Wilshire Planters GFRC with Greenscreen® Trellis

An attractive, easy-to-install solution for creating privacy or hiding unattractive elements like building systems. Lightweight GFRC concrete planter (available in colors and textures), and Greenscreen® trellis, framed on top and sides, with vertical supports to fit in planter lip. Trellis is available in various powder-coat colors.

Wilshire Planters, GFRC with Greenscreen® Trellis

WILSHIRE PLANTERS GFRC WITH GREENSCREEN® TRELLIS

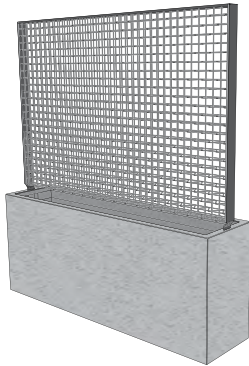

Planter with Trellis

THE COMPLETE WILSHIRE COLLECTION

For additional shapes and materials, visit tournesol.com/collections/wilshire

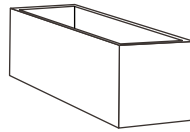

Rectangle

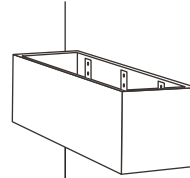

Hanging Box

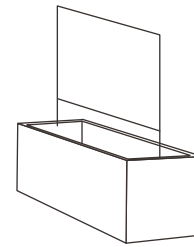

Trellis, Laser-Cut Screen

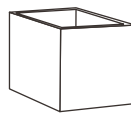

Square

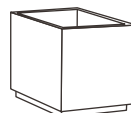

Toe Kick

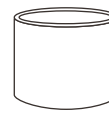

Round



Round with Toe Kick

OPTIONS

Standard Wilshire Planters can be modified with a broad array of options without incurring custom charges. Options are limited to those products that can support them. Speak to a Tournesol Advisor to discuss which options will work with your project.



Irrigation



Accessory Pockets



TourneSeal



Drain Holes



Matching Saucer

Wilshire Planters, GFRC with Greenscreen® Trellis

- Durable, lightweight GFRC planter with powder-coated Greenscreen® trellis. 2"W x 2"L x 3"D grid.
- Trellis vertical supports fit into planter lip and are secured with discrete stainless-steel fasteners.
- Trellis is framed on top and sides and extends to planter edge so adjacent planters form a seamless trellis wall.
- Select a Greenscreen Trellis color in addition to a GFRC color and texture. Standard drain holes included.

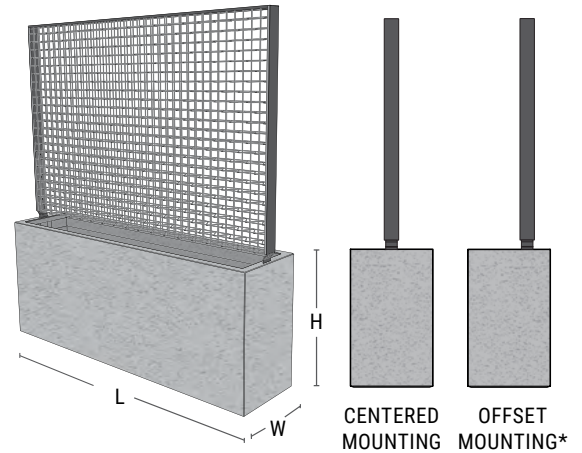

* Add "-X" after product number to indicate optional offset mounting.

| PRODUCT | LENGTH | WIDTH | HEIGHT OF PLANTER | TOTAL HEIGHT WITH TRELLIS | WEIGHT (LBS.) | VOLUME (CUBIC FT.) | IRRIGATION |
|----------------|--------|-------|-------------------|---------------------------|---------------|--------------------|--------------|
| WCX2-481824-74 | 48" | 18" | 24" | 74" | 318 | 9.7 | CWM-R1620-2k |
| WCX2-481830-80 | 48" | 18" | 30" | 80" | 355 | 14.6 | CWM-R1620-2k |
| WCX2-481836-86 | 48" | 18" | 36" | 86" | 373 | 19.3 | CWM-R1620-2k |
| WCX2-482424-74 | 48" | 24" | 24" | 74" | 353 | 12.3 | CWM-R1620-2k |
| WCX2-482430-80 | 48" | 24" | 30" | 80" | 395 | 18.6 | CWM-R1620-2k |
| WCX2-482436-86 | 48" | 24" | 36" | 86" | 490 | 24.7 | CWM-R1620-2k |
| WCX2-721824-74 | 72" | 18" | 24" | 74" | 450 | 15 | CWM-R1620-3k |
| WCX2-721830-80 | 72" | 18" | 30" | 80" | 510 | 22.5 | CWM-R1620-3k |
| WCX2-721836-86 | 72" | 18" | 36" | 86" | 540 | 30.2 | CWM-R1620-3k |
| WCX2-722424-74 | 72" | 24" | 24" | 74" | 490 | 13.3 | CWM-R1620-3k |
| WCX2-722430-80 | 72" | 24" | 30" | 80" | 560 | 20.1 | CWM-R1620-3k |
| WCX2-722436-86 | 72" | 24" | 36" | 86" | 700 | 27 | CWM-R1620-3k |
| WCX2-961824-74 | 96" | 18" | 24" | 74" | 605 | 16.9 | CWM-R1620-4k |
| WCX2-961830-80 | 96" | 18" | 30" | 80" | 685 | 25.6 | CWM-R1620-3k |
| WCX2-961836-86 | 96" | 18" | 36" | 86" | 690 | 34.1 | CWM-R1620-4k |
| WCX2-962424-74 | 96" | 24" | 24" | 74" | 625 | 20.2 | CWM-R1620-4k |
| WCX2-962430-80 | 96" | 24" | 30" | 80" | 750 | 30.6 | CWM-R1620-4k |
| WCX2-962436-86 | 96" | 24" | 36" | 86" | 925 | 40.7 | CWM-R1620-4k |



Wilshire Planters GFRC with Laser-Cut Screen

An attractive, easy-to-install solution for creating privacy or hiding unattractive elements such as building systems. Available in lightweight GFRC concrete or FRP Fiberglass in all colors and textures. Steel laser-cut screen is available in all powder-coat finishes.

Wilshire Planters, GFRC with Laser-Cut Screen

WILSHIRE PLANTERS GFRC WITH LASER-CUT SCREEN

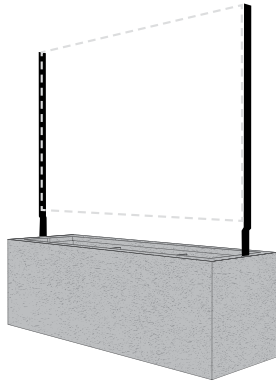

Planter with Laser-Cut Screen

THE COMPLETE WILSHIRE COLLECTION

For additional shapes and materials, visit tournesol.com/collections/wilshire

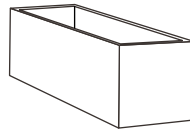

Rectangle

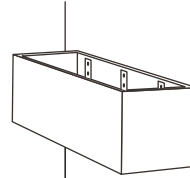

Hanging Box

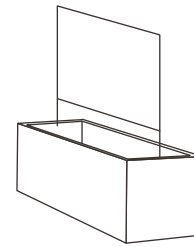

Trellis, Laser-Cut Screen

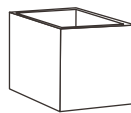

Square

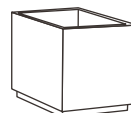

Toe Kick

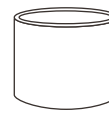

Round



Round with Toe Kick

OPTIONS

Standard Wilshire Planters can be modified with a broad array of options without incurring custom charges. Options are limited to those products that can support them. Speak to a Tournesol Advisor to discuss which options will work with your project.



Irrigation



Accessory Pockets



TourneSeal



Drain Holes



Matching Saucer

Wilshire Planters GFRC with Laser-Cut Screen

Select one of the patterns shown at right or submit your own artwork.

Available in powder-coated or weathering steel.

Shown at right in 48"L x 48"H



48"L x 48"H

**WCX-48 INCLUDES ONE
48"L x 48"H LASER-CUT SCREEN.**



72"L x 48"H

**WCX-72 INCLUDES ONE
72"L x 48"H LASER-CUT SCREEN.**



96"L x 48"H

**WCX-96 INCLUDES ONE
96"L x 48"H LASER-CUT SCREEN.**

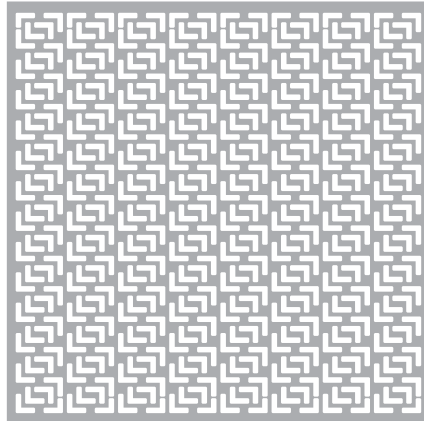

Pattern 2 - 30% Open

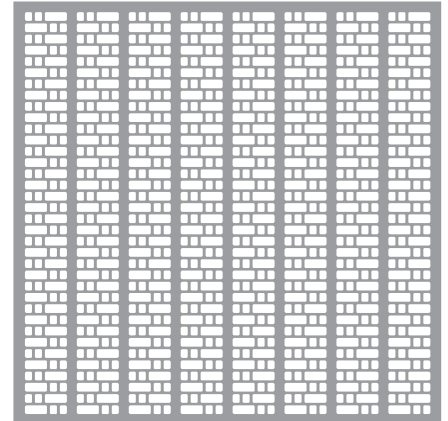

Pattern 3 - 32% Open

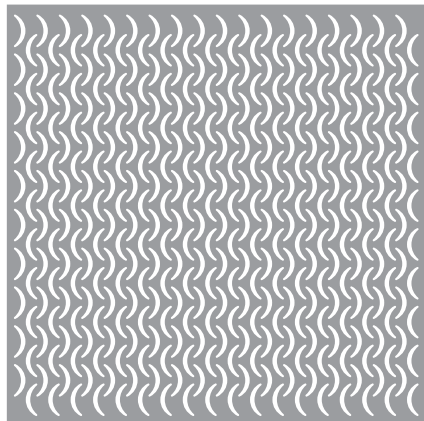

Pattern 4 - 20% Open

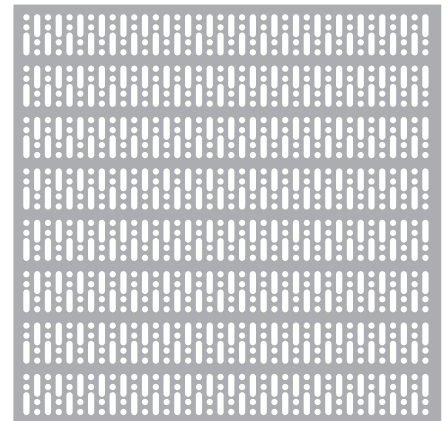

Pattern 6 - 25% Open

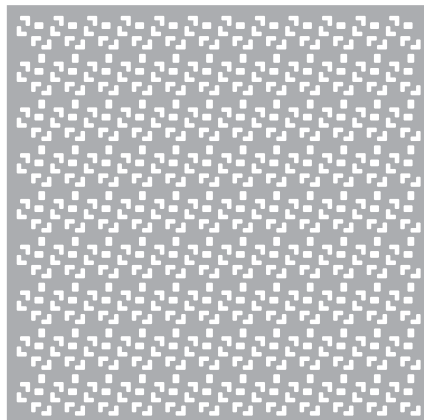

Pattern 7 - 17% Open

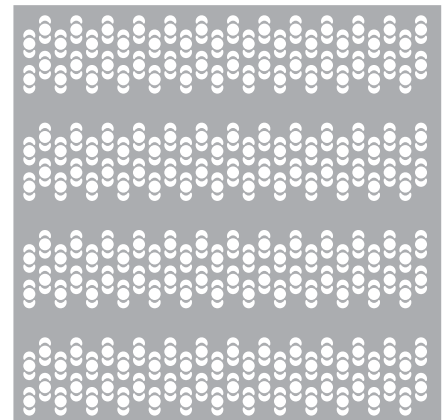

Pattern 8 - 22% Open

CUSTOM PATTERN OPTIONS

| Part No. | Description |
|---------------|---|
| WXS-LC | Custom laser-cut screen charge, varies by design and size |
| WXS Setup CAD | One-time setup charge for laser-cut screens, customer to provide CAD drawings |
| WXS Setup PDF | One-time setup charge for laser-cut screens, customer to provide PDF drawings |

Wilshire Planters GFRC with Laser-Cut Screen

- Durable Glass Fiber Reinforced Concrete
- Laser-cut steel screen
- Standard patterns & custom available
- Hidden support brackets
- Drain holes standard

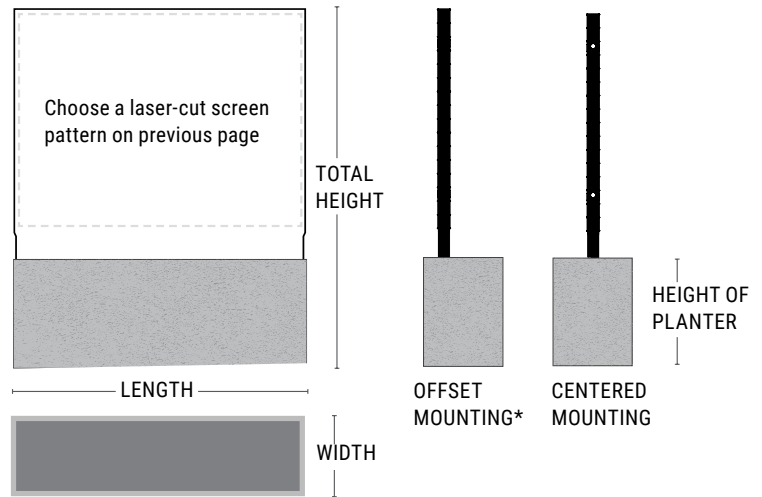

* When specifying offset mounting, add "-X" after product number. Example: WCX-481824-74 is centered mounting, and WCX-481824-74-X is offset mounting.

| PRODUCT | LENGTH | WIDTH | HEIGHT OF PLANTER | TOTAL HEIGHT WITH SCREEN | WEIGHT (LBS.) | VOLUME (CUBIC FT.) | IRRIGATION | LASER-CUT SCREEN |
|---------------|--------|-------|-------------------|--------------------------|---------------|--------------------|--------------|--------------------------|
| WCX-481824-74 | 48" | 18" | 24" | 74" | 378 | 11.5 | CWM-R1620-2k | Options on previous page |
| WCX-481830-80 | 48" | 18" | 30" | 80" | 425 | 17.3 | CWM-R1620-2k | Options on previous page |
| WCX-481836-86 | 48" | 18" | 36" | 86" | 484 | 23.1 | CWM-R1620-2k | Options on previous page |
| WCX-482424-74 | 48" | 24" | 24" | 74" | 421 | 13.5 | CWM-R1620-2k | Options on previous page |
| WCX-482430-80 | 48" | 24" | 30" | 80" | 474 | 20.2 | CWM-R1620-2k | Options on previous page |
| WCX-482436-86 | 48" | 24" | 36" | 86" | 536 | 27 | CWM-R1620-2k | Options on previous page |
| WCX-721824-74 | 72" | 18" | 24" | 74" | 536 | 13.5 | CWM-R1620-3k | Options on previous page |
| WCX-721830-80 | 72" | 18" | 30" | 80" | 605 | 25.5 | CWM-R1620-3k | Options on previous page |
| WCX-721836-86 | 72" | 18" | 36" | 86" | 703 | 34 | CWM-R1620-3k | Options on previous page |
| WCX-722424-74 | 72" | 24" | 24" | 74" | 590 | 15 | CWM-R1620-3k | Options on previous page |
| WCX-722430-80 | 72" | 24" | 30" | 80" | 664 | 22.6 | CWM-R1620-3k | Options on previous page |
| WCX-722436-86 | 72" | 24" | 36" | 86" | 768 | 30.1 | CWM-R1620-3k | Options on previous page |
| WCX-961824-74 | 96" | 18" | 24" | 74" | 718 | 18.8 | CWM-R1620-4k | Options on previous page |
| WCX-961830-80 | 96" | 18" | 30" | 80" | 807 | 28.2 | CWM-R1620-3k | Options on previous page |
| WCX-961836-86 | 96" | 18" | 36" | 86" | 901 | 37.7 | CWM-R1620-4k | Options on previous page |
| WCX-962424-74 | 96" | 24" | 24" | 74" | 785 | 23.3 | CWM-R1620-4k | Options on previous page |
| WCX-962430-80 | 96" | 24" | 30" | 80" | 879 | 35 | CWM-R1620-4k | Options on previous page |
| WCX-962436-86 | 96" | 24" | 36" | 86" | 978 | 46.7 | CWM-R1620-4k | Options on previous page |



Wilshire Planters FRP Rectangle & Square

The addition of glass fibers turns ordinary resin into a superhero! The Wilshire Planters made from FRP are the lightest among the collection yet can retain moisture-laden soil without deforming. Surface-applied textures add scratch-resistance and are available in stock or custom colors. Available in 18 colors and three textures.

Wilshire Planters, FRP Rectangle & Square

WILSHIRE PLANTERS, FRP RECTANGLES & SQUARES

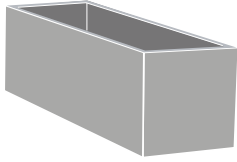

Rectangle

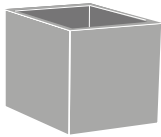

Square

THE COMPLETE WILSHIRE COLLECTION

For additional shapes and materials, visit tournesol.com/collections/wilshire

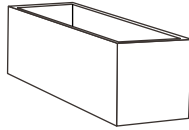

Rectangle

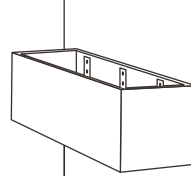

Hanging Box

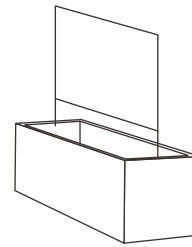

Trellis, Laser-Cut Screen



Square

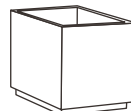

Toe Kick

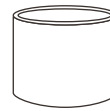

Round



Round with Toe Kick

OPTIONS

Standard Wilshire Planters can be modified with a broad array of options without incurring custom charges. Options are limited to those products that can support them. Speak to a Tournesol Advisor to discuss which options will work with your project.



Irrigation



Change Dimension



Accessory Pockets



Scoops



Casters



Tourneseal



Drain Holes



Matching Saucer



False Bottom



Tie Downs



Bottom Reinforcement



Lift Channels



Custom Color

Wilshire Planters FRP Rectangle & Square

- Lightweight fiberglass
- Available in three standard textures
- Huge range of sizes
- Drain holes upon request or installed in field

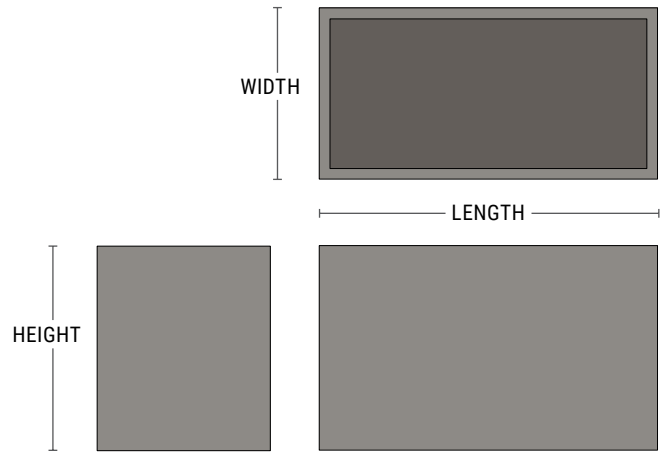

| PRODUCT | SHAPE | LENGTH | WIDTH | HEIGHT | WEIGHT (LBS.) | VOLUME (CUBIC FT.) | INTERIOR TOP | INTERIOR BOTTOM | IRRIGATION |
|-----------|-----------|--------|-------|--------|---------------|--------------------|--------------|-----------------|------------------------|
| WR-1800F | Square | 18" | 18" | 20" | 26 | 3.4 | 15" x 15" | 14.5" x 14.5" | - |
| WR-241012 | Rectangle | 24" | 10" | 12" | 16 | 1.5 | 21" x 7" | 23.5" x 9.5" | CWM-R1109-MS |
| WR-241218 | Rectangle | 24" | 12" | 18" | 24 | 2.8 | 21" x 9" | 23.5" x 11.5" | CWM-R1114-MS |
| WR-241236 | Rectangle | 24" | 12" | 36" | 41 | 5.6 | 21" x 9" | 23.5" x 11.5" | CWM-R1120-MS |
| WR-241818 | Rectangle | 24" | 18" | 18" | 29 | 4.3 | 21" x 15" | 23.5" x 17.5" | CWM-R1114-MS |
| WR-241824 | Rectangle | 24" | 18" | 24" | 36 | 5.7 | 21" x 15" | 23.5" x 17.5" | CWM-R1620-MS |
| WR-241830 | Rectangle | 24" | 18" | 30" | 42 | 7 | 21" x 15" | 23.5" x 17.5" | CWM-R1620-MS |
| WR-241836 | Rectangle | 24" | 18" | 36" | 49 | 8.4 | 21" x 15" | 23.5" x 17.5" | CWM-R1620-MS |
| WR-242418 | Square | 24" | 24" | 18" | 34 | 5.7 | 21" x 21" | 23.5" x 23.5" | CWM-R1614-MS |
| WR-2400F | Square | 24" | 24" | 24" | 42 | 8 | 21" x 21" | 20.5" x 20.5" | CWC-R1850/CWM-R1114-2k |
| WR-3000F | Square | 30" | 30" | 27" | 59 | 14 | 27" x 27" | 25.5" x 25.5" | CWM-R1620-2k |
| WR-361012 | Rectangle | 36" | 10" | 12" | 23 | 2.3 | 33" x 7" | 35.5" x 9.5" | CWM-R1109-2k |
| WR-361218 | Rectangle | 36" | 12" | 18" | 32 | 4.3 | 33" x 9" | 35.5" x 11.5" | CWM-R1114-2k |
| WR-361236 | Rectangle | 36" | 12" | 36" | 55 | 8.5 | 33" x 9" | 35.5" x 11.5" | CWM-R1120-2k |
| WR-361818 | Rectangle | 36" | 18" | 18" | 38 | 6.5 | 33" x 15" | 35.5" x 17.5" | CWM-R1114-2k |
| WR-361824 | Rectangle | 36" | 18" | 24" | 47 | 8.6 | 33" x 15" | 35.5" x 17.5" | CWM-R2020-MS |
| WR-361830 | Rectangle | 36" | 18" | 30" | 56 | 10.5 | 33" x 15" | 35.5" x 17.5" | CWM-R2020-MS |
| WR-361836 | Rectangle | 36" | 18" | 36" | 64 | 12.7 | 33" x 15" | 35.5" x 17.5" | CWM-R2020-MS |
| WR-362418 | Rectangle | 36" | 24" | 18" | 44 | 8.7 | 33" x 21" | 35.5" x 23.5" | CWM-R2014-MS |
| WR-362424 | Rectangle | 36" | 24" | 24" | 54 | 11.6 | 33" x 21" | 35.5" x 23.5" | CWM-R2920-MS |

Wilshire Planters FRP Rectangle & Square

- Lightweight fiberglass
- Available in three standard textures
- Huge range of sizes
- Drain holes upon request or installed in field

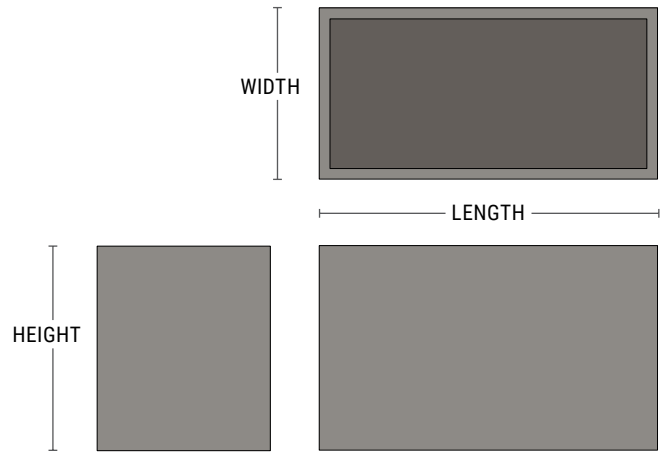

| PRODUCT | SHAPE | LENGTH | WIDTH | HEIGHT | WEIGHT (LBS.) | VOLUME (CUBIC FT.) | INTERIOR TOP | INTERIOR BOTTOM | IRRIGATION |
|-----------|-----------|--------|-------|--------|---------------|--------------------|--------------|-----------------|--------------|
| WR-362430 | Rectangle | 36" | 24" | 30" | 64 | 14.1 | 33" x 21" | 35.5" x 23.5" | CWM-R2920-MS |
| WR-362436 | Rectangle | 36" | 24" | 36" | 73 | 17.4 | 33" x 21" | 35.5" x 23.5" | CWM-R2920-MS |
| WR-362442 | Rectangle | 36" | 24" | 42" | 83 | 19.7 | 33" x 21" | 35.5" x 23.5" | CWM-R2920-MS |
| WR-363018 | Rectangle | 36" | 30" | 18" | 51 | 10.9 | 33" x 27" | 35.5" x 29.5" | CWM-R2914-MS |
| WR-363024 | Rectangle | 36" | 30" | 24" | 61 | 13.7 | 33" x 27" | 35.5" x 29.5" | CWM-R2920-MS |
| WR-363030 | Rectangle | 36" | 30" | 30" | 72 | 17.3 | 33" x 27" | 35.5" x 29.5" | CWM-R2920-MS |
| WR-363036 | Rectangle | 36" | 30" | 36" | 82 | 20.8 | 33" x 27" | 35.5" x 29.5" | CWM-R2920-MS |
| WR-363042 | Rectangle | 36" | 30" | 42" | 93 | 24.4 | 33" x 27" | 35.5" x 29.5" | CWM-R2920-MS |
| WR-363618 | Square | 36" | 36" | 18" | 57 | 12.4 | 31" x 31" | 35.5" x 35.5" | CWM-R1114-2k |
| WR-363624 | Square | 36" | 36" | 24" | 68 | 16.2 | 31" x 31" | 35.5" x 35.5" | CWM-R1120-2k |
| WR-3600F | Square | 36" | 36" | 30" | 80 | 22 | 31" x 31" | 35.5" x 35.5" | CWM-R1620-2k |
| WR-363636 | Square | 36" | 36" | 36" | 91 | 24.6 | 31" x 31" | 35.5" x 35.5" | CWM-R1120-2k |
| WR-363642 | Square | 36" | 36" | 42" | 103 | 28.8 | 31" x 31" | 35.5" x 35.5" | CWM-R1120-2k |
| WR-4200F | Square | 42" | 42" | 36" | 110 | 37 | 37" x 37" | 43.5" x 43.5" | CWM-R2920-2K |
| WR-481012 | Rectangle | 48" | 10" | 12" | 29 | 3.1 | 45" x 7" | 47.5" x 9.5" | CWM-R1109-2k |
| WR-481218 | Rectangle | 48" | 12" | 18" | 41 | 5.7 | 45" x 9" | 47.5" x 11.5" | CWM-R1114-2k |
| WR-481236 | Rectangle | 48" | 12" | 36" | 69 | 11.3 | 45" x 9" | 47.5" x 11.5" | CWM-R1120-2k |
| WR-481818 | Rectangle | 48" | 18" | 18" | 48 | 8.6 | 45" x 15" | 47.5" x 17.5" | CWM-R1114-2k |
| WR-481824 | Rectangle | 48" | 18" | 24" | 58 | 11.5 | 45" x 15" | 47.5" x 17.5" | CWM-R1620-2k |
| WR-481830 | Rectangle | 48" | 18" | 30" | 69 | 13.5 | 45" x 15" | 47.5" x 17.5" | CWM-R1620-2k |

Wilshire Planters FRP Rectangle & Square

- Lightweight fiberglass
- Available in three standard textures
- Huge range of sizes
- Drain holes upon request or installed in field

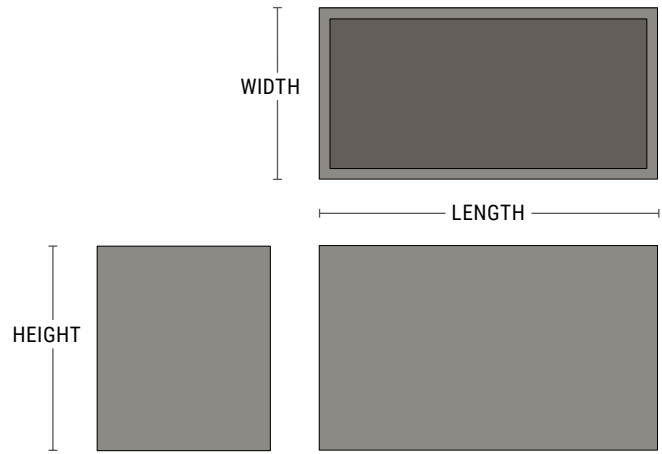

| PRODUCT | SHAPE | LENGTH | WIDTH | HEIGHT | WEIGHT (LBS.) | VOLUME (CUBIC FT.) | INTERIOR TOP | INTERIOR BOTTOM | IRRIGATION |
|-----------|-----------|--------|-------|--------|---------------|--------------------|--------------|-----------------|--------------|
| WR-481836 | Rectangle | 48" | 18" | 36" | 79 | 17 | 45" x 15" | 47.5" x 17.5" | CWM-R1620-2k |
| WR-482418 | Rectangle | 48" | 24" | 18" | 55 | 11.5 | 45" x 21" | 47.5" x 23.5" | CWM-R1614-2k |
| WR-482424 | Rectangle | 48" | 24" | 24" | 66 | 15 | 45" x 21" | 47.5" x 23.5" | CWM-R1620-2k |
| WR-482430 | Rectangle | 48" | 24" | 30" | 78 | 18.8 | 45" x 21" | 47.5" x 23.5" | CWM-R1620-2k |
| WR-482436 | Rectangle | 48" | 24" | 36" | 89 | 23.3 | 45" x 21" | 47.5" x 23.5" | CWM-R1620-2k |
| WR-482442 | Rectangle | 48" | 24" | 42" | 101 | 26.3 | 45" x 21" | 47.5" x 23.5" | CWM-R1620-2k |
| WR-483018 | Rectangle | 48" | 30" | 18" | 62 | 14.5 | 45" x 27" | 47.5" x 29.5" | CWM-R1614-2k |
| WR-483024 | Rectangle | 48" | 30" | 24" | 74 | 18.3 | 45" x 27" | 47.5" x 29.5" | CWM-R1620-2k |
| WR-483030 | Rectangle | 48" | 30" | 30" | 87 | 23 | 45" x 27" | 47.5" x 29.5" | CWM-R1620-2k |
| WR-483036 | Rectangle | 48" | 30" | 36" | 99 | 27.8 | 45" x 27" | 47.5" x 29.5" | CWM-R1620-2k |
| WR-483042 | Rectangle | 48" | 30" | 42" | 112 | 32.5 | 45" x 27" | 47.5" x 29.5" | CWM-R1620-2k |
| WR-483618 | Rectangle | 48" | 36" | 18" | 69 | 16.6 | 43" x 31" | 47.5" x 35.5" | CWM-R1614-2k |
| WR-483624 | Rectangle | 48" | 36" | 24" | 84 | 21.7 | 43" x 31" | 47.5" x 35.5" | CWM-R1620-2k |
| WR-483630 | Rectangle | 48" | 36" | 30" | 98 | 27.4 | 43" x 31" | 47.5" x 35.5" | CWM-R1620-2k |
| WR-483636 | Rectangle | 48" | 36" | 36" | 111 | 33 | 43" x 31" | 47.5" x 35.5" | CWM-R1620-2k |
| WR-483642 | Rectangle | 48" | 36" | 42" | 125 | 38.6 | 43" x 31" | 47.5" x 35.5" | CWM-R1620-2k |
| WR-484818 | Rectangle | 48" | 48" | 18" | 85 | 22.1 | 43" x 43" | 47.5" x 47.5" | CWM-R1614-2k |
| WR-4824F | Square | 48" | 48" | 24" | 101 | 29 | 43" x 43" | 43.5" x 43.5" | CWM-R2914-2k |
| WR-484830 | Square | 48" | 48" | 30" | 116 | 36.3 | 43" x 43" | 47.5" x 47.5" | CWM-R1620-2k |
| WR-4800F | Square | 48" | 48" | 36" | 132 | 48 | 43" x 43" | 43.5" x 43.5" | CWM-R2920-2k |

Wilshire Planters FRP Rectangle & Square

- Lightweight fiberglass
- Available in three standard textures
- Huge range of sizes
- Drain holes upon request or installed in field

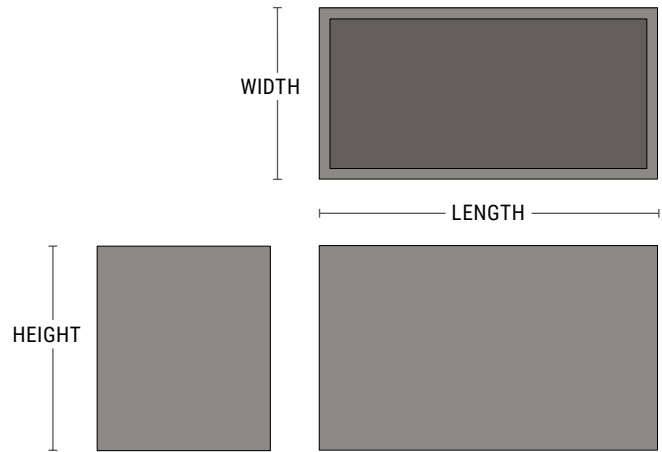

| PRODUCT | SHAPE | LENGTH | WIDTH | HEIGHT | WEIGHT (LBS.) | VOLUME (CUBIC FT.) | INTERIOR TOP | INTERIOR BOTTOM | IRRIGATION |
|-----------|-----------|--------|-------|--------|---------------|--------------------|--------------|-----------------|--------------|
| WR-484842 | Square | 48" | 48" | 42" | 147 | 51.1 | 43" x 43" | 47.5" x 47.5" | CWM-R1620-2k |
| WR-601012 | Rectangle | 60" | 10" | 12" | 36 | 3.9 | 57" x 7" | 59.5" x 9.5" | CWM-R1109-2k |
| WR-601218 | Rectangle | 60" | 12" | 18" | 50 | 7.1 | 57" x 9" | 59.5" x 11.5" | CWM-R1114-2k |
| WR-601236 | Rectangle | 60" | 12" | 36" | 85 | 14.2 | 57" x 9" | 59.5" x 11.5" | CWM-R1120-2k |
| WR-601818 | Rectangle | 60" | 18" | 18" | 58 | 10.8 | 57" x 15" | 59.5" x 17.5" | CWM-R1114-2k |
| WR-601824 | Rectangle | 60" | 18" | 24" | 71 | 14.4 | 57" x 15" | 59.5" x 17.5" | CWM-R1620-2k |
| WR-601830 | Rectangle | 60" | 18" | 30" | 84 | 16.9 | 57" x 15" | 59.5" x 17.5" | CWM-R2020-2k |
| WR-601836 | Rectangle | 60" | 18" | 36" | 96 | 21.2 | 57" x 15" | 59.5" x 17.5" | CWM-R2020-2k |
| WR-602418 | Rectangle | 60" | 24" | 18" | 66 | 14.5 | 57" x 21" | 59.5" x 23.5" | CWM-R2014-2k |
| WR-602424 | Rectangle | 60" | 24" | 24" | 80 | 18.8 | 57" x 21" | 59.5" x 23.5" | CWM-R2020-2k |
| WR-602430 | Rectangle | 60" | 24" | 30" | 94 | 23.5 | 57" x 21" | 59.5" x 23.5" | CWM-R2020-2k |
| WR-602436 | Rectangle | 60" | 24" | 36" | 108 | 29.1 | 57" x 21" | 59.5" x 23.5" | CWM-R2020-2k |
| WR-602442 | Rectangle | 60" | 24" | 42" | 121 | 32.9 | 57" x 21" | 59.5" x 23.5" | CWM-R2020-2k |
| WR-603018 | Rectangle | 60" | 30" | 18" | 75 | 18.2 | 57" x 27" | 59.5" x 29.5" | CWM-R2014-2k |
| WR-603024 | Rectangle | 60" | 30" | 24" | 89 | 22.8 | 57" x 27" | 59.5" x 29.5" | CWM-R2020-2k |
| WR-603030 | Rectangle | 60" | 30" | 30" | 104 | 28.8 | 57" x 27" | 59.5" x 29.5" | CWM-R2020-2k |
| WR-603036 | Rectangle | 60" | 30" | 36" | 119 | 34.7 | 57" x 27" | 59.5" x 29.5" | CWM-R2020-2k |
| WR-603042 | Rectangle | 60" | 30" | 42" | 133 | 40.7 | 57" x 27" | 59.5" x 29.5" | CWM-R2020-2k |
| WR-603618 | Rectangle | 60" | 36" | 18" | 83 | 20.7 | 55" x 31" | 59.5" x 35.5" | CWM-R2014-2k |
| WR-603624 | Rectangle | 60" | 36" | 24" | 99 | 27.3 | 55" x 31" | 59.5" x 35.5" | CWM-R2020-2k |

Wilshire Planters FRP Rectangle & Square

- Lightweight fiberglass
- Available in three standard textures
- Huge range of sizes
- Drain holes upon request or installed in field

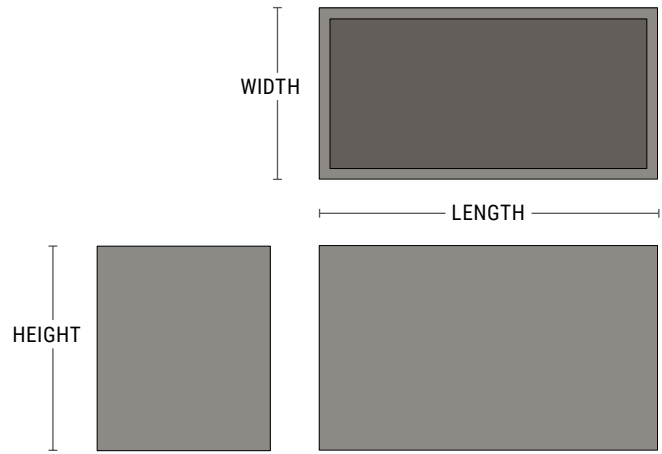

| PRODUCT | SHAPE | LENGTH | WIDTH | HEIGHT | WEIGHT (LBS.) | VOLUME (CUBIC FT.) | INTERIOR TOP | INTERIOR BOTTOM | IRRIGATION |
|-----------|-----------|--------|-------|--------|---------------|--------------------|--------------|-----------------|--------------|
| WR-603630 | Rectangle | 60" | 36" | 30" | 114 | 34.4 | 55" x 31" | 59.5" x 35.5" | CWM-R2020-2k |
| WR-603636 | Rectangle | 60" | 36" | 36" | 130 | 41.4 | 55" x 31" | 59.5" x 35.5" | CWM-R2020-2k |
| WR-603642 | Rectangle | 60" | 36" | 42" | 146 | 48.5 | 55" x 31" | 59.5" x 35.5" | CWM-R2020-2k |
| WR-604818 | Rectangle | 60" | 48" | 18" | 99 | 27.7 | 55" x 43" | 59.5" x 47.5" | CWM-R2014-2k |
| WR-604824 | Rectangle | 60" | 48" | 24" | 117 | 36.3 | 55" x 43" | 59.5" x 47.5" | CWM-R2014-2k |
| WR-604830 | Rectangle | 60" | 48" | 30" | 135 | 45.7 | 55" x 43" | 59.5" x 47.5" | CWM-R2020-2k |
| WR-604836 | Rectangle | 60" | 48" | 36" | 152 | 54.9 | 55" x 43" | 59.5" x 47.5" | CWM-R2020-2k |
| WR-604842 | Rectangle | 60" | 48" | 42" | 170 | 64.3 | 55" x 43" | 59.5" x 47.5" | CWM-R2020-2k |
| WR-6000F | Square | 60" | 60" | 42" | 194 | 80 | 55" x 55" | 55.5" x 55.5" | CWM-R2920-4k |
| WR-721012 | Rectangle | 72" | 10" | 12" | 42 | 4.7 | 69" x 7" | 71.5" x 9.5" | CWM-R1109-3k |
| WR-721218 | Rectangle | 72" | 12" | 18" | 59 | 8.5 | 69" x 9" | 71.5" x 11.5" | CWM-R1114-3k |
| WR-721236 | Rectangle | 72" | 12" | 36" | 100 | 17 | 69" x 9" | 71.5" x 11.5" | CWM-R1120-3k |
| WR-721818 | Rectangle | 72" | 18" | 18" | 68 | 12.9 | 69" x 15" | 71.5" x 17.5" | CWM-R1114-3k |
| WR-721824 | Rectangle | 72" | 18" | 24" | 82 | 17.3 | 69" x 15" | 71.5" x 17.5" | CWM-R1620-3k |
| WR-721830 | Rectangle | 72" | 18" | 30" | 97 | 20.2 | 69" x 15" | 71.5" x 17.5" | CWM-R1620-3k |
| WR-721836 | Rectangle | 72" | 18" | 36" | 112 | 25.5 | 69" x 15" | 71.5" x 17.5" | CWM-R1620-3k |
| WR-722418 | Rectangle | 72" | 24" | 18" | 77 | 17.4 | 69" x 21" | 71.5" x 23.5" | CWM-R1614-3k |
| WR-722424 | Rectangle | 72" | 24" | 24" | 93 | 22.6 | 69" x 21" | 71.5" x 23.5" | CWM-R1620-3k |
| WR-722430 | Rectangle | 72" | 24" | 30" | 108 | 28.2 | 69" x 21" | 71.5" x 23.5" | CWM-R1620-3k |
| WR-722436 | Rectangle | 72" | 24" | 36" | 124 | 35 | 69" x 21" | 71.5" x 23.5" | CWM-R1620-3k |

Wilshire Planters FRP Rectangle & Square

- Lightweight fiberglass
- Available in three standard textures
- Huge range of sizes
- Drain holes upon request or installed in field

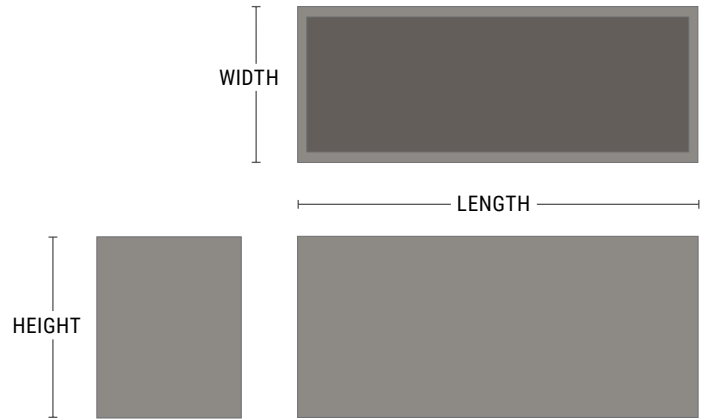

| PRODUCT | SHAPE | LENGTH | WIDTH | HEIGHT | WEIGHT (LBS.) | VOLUME (CUBIC FT.) | INTERIOR TOP | INTERIOR BOTTOM | IRRIGATION |
|-----------|-----------|--------|-------|--------|---------------|--------------------|--------------|-----------------|----------------|
| WR-722442 | Rectangle | 72" | 24" | 42" | 140 | 39.5 | 69" x 21" | 71.5" x 23.5" | CWM-R1620-3k |
| WR-723018 | Rectangle | 72" | 30" | 18" | 86 | 21.8 | 69" x 27" | 71.5" x 29.5" | CWM-R1614-3k |
| WR-723024 | Rectangle | 72" | 30" | 24" | 103 | 27.4 | 69" x 27" | 71.5" x 29.5" | CWM-R1620-3k |
| WR-723030 | Rectangle | 72" | 30" | 30" | 120 | 34.5 | 69" x 27" | 71.5" x 29.5" | CWM-R1620-3k |
| WR-723036 | Rectangle | 72" | 30" | 36" | 136 | 41.7 | 69" x 27" | 71.5" x 29.5" | CWM-R1620-3k |
| WR-723042 | Rectangle | 72" | 30" | 42" | 153 | 48.8 | 69" x 27" | 71.5" x 29.5" | CWM-R1620-3k |
| WR-723618 | Rectangle | 72" | 36" | 18" | 95 | 24.9 | 67" x 31" | 71.5" x 35.5" | CWM-R1614-3k |
| WR-723624 | Rectangle | 72" | 36" | 24" | 113 | 32.8 | 67" x 31" | 71.5" x 35.5" | CWM-R1620-3k |
| WR-723630 | Rectangle | 72" | 36" | 30" | 131 | 41.3 | 67" x 31" | 71.5" x 35.5" | CWM-R1620-3k |
| WR-723636 | Rectangle | 72" | 36" | 36" | 148 | 49.8 | 67" x 31" | 71.5" x 35.5" | CWM-R1620-3k |
| WR-723642 | Rectangle | 72" | 36" | 42" | 166 | 58.3 | 67" x 31" | 71.5" x 35.5" | CWM-R1620-3k |
| WR-724818 | Rectangle | 72" | 48" | 18" | 114 | 33.3 | 67" x 43" | 71.5" x 47.5" | CWM-R1614-3k |
| WR-724824 | Rectangle | 72" | 48" | 24" | 128 | 43.6 | 67" x 43" | 71.5" x 47.5" | CWM-R1614-3k |
| WR-724830 | Rectangle | 72" | 48" | 30" | 146 | 55 | 67" x 43" | 71.5" x 47.5" | CWM-R1620-3k |
| WR-724836 | Rectangle | 72" | 48" | 36" | 165 | 66.1 | 67" x 43" | 71.5" x 47.5" | CWM-R1620-3k |
| WR-724842 | Rectangle | 72" | 48" | 42" | 184 | 77.4 | 67" x 43" | 71.5" x 47.5" | CWM-R1620-3k |
| WR-7200F | Square | 72" | 72" | 42" | 234 | 120 | 67" x 67" | 67.5" x 67.5" | CWM-R2020-4k-E |
| WR-961012 | Rectangle | 96" | 10" | 12" | 52 | 6.3 | 93" x 7" | 95.5" x 9.5" | CWM-R1109-5k |
| WR-961218 | Rectangle | 96" | 12" | 18" | 73 | 11.4 | 93" x 9" | 95.5" x 11.5" | CWM-R1114-4k |
| WR-961236 | Rectangle | 96" | 12" | 36" | 123 | 22.6 | 93" x 9" | 95.5" x 11.5" | CWM-R1120-4k |

Wilshire Planters FRP Rectangle & Square

- Lightweight fiberglass
- Available in three standard textures
- Huge range of sizes
- Drain holes upon request or installed in field

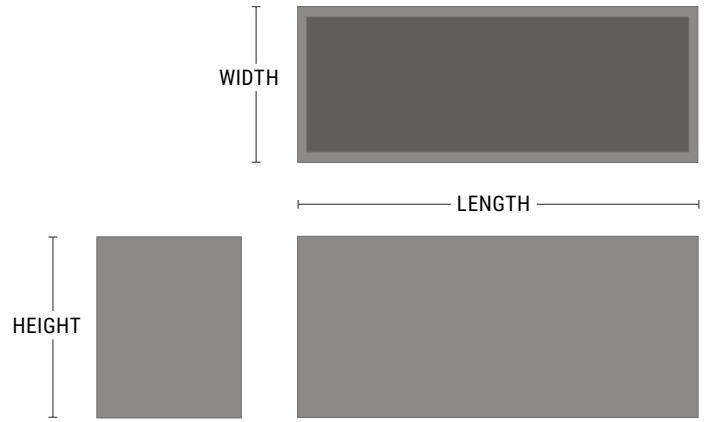

| PRODUCT | SHAPE | LENGTH | WIDTH | HEIGHT | WEIGHT (LBS.) | VOLUME (CUBIC FT.) | INTERIOR TOP | INTERIOR BOTTOM | IRRIGATION |
|-----------|-----------|--------|-------|--------|---------------|--------------------|--------------|-----------------|--------------|
| WR-961818 | Rectangle | 96" | 18" | 18" | 83 | 17.3 | 93" x 15" | 95.5" x 17.5" | CWM-R1114-4k |
| WR-961824 | Rectangle | 96" | 18" | 24" | 101 | 23.1 | 93" x 15" | 95.5" x 17.5" | CWM-R1620-4k |
| WR-961830 | Rectangle | 96" | 18" | 30" | 119 | 27 | 93" x 15" | 95.5" x 17.5" | CWM-R1620-4k |
| WR-961836 | Rectangle | 96" | 18" | 36" | 137 | 34 | 93" x 15" | 95.5" x 17.5" | CWM-R1620-4k |
| WR-962418 | Rectangle | 96" | 24" | 18" | 94 | 23.2 | 93" x 21" | 95.5" x 23.5" | CWM-R1614-4k |
| WR-962424 | Rectangle | 96" | 24" | 24" | 113 | 30.1 | 93" x 21" | 95.5" x 23.5" | CWM-R1620-4k |
| WR-962430 | Rectangle | 96" | 24" | 30" | 131 | 37.7 | 93" x 21" | 95.5" x 23.5" | CWM-R1620-4k |
| WR-962436 | Rectangle | 96" | 24" | 36" | 150 | 46.7 | 93" x 21" | 95.5" x 23.5" | CWM-R1620-4k |
| WR-962442 | Rectangle | 96" | 24" | 42" | 169 | 52.7 | 93" x 21" | 95.5" x 23.5" | CWM-R1620-4k |
| WR-963018 | Rectangle | 96" | 30" | 18" | 105 | 27.6 | 93" x 27" | 95.5" x 29.5" | CWM-R1614-4k |
| WR-963024 | Rectangle | 96" | 30" | 24" | 124 | 36.6 | 93" x 27" | 95.5" x 29.5" | CWM-R1620-4k |
| WR-963030 | Rectangle | 96" | 30" | 30" | 144 | 46.1 | 93" x 27" | 95.5" x 29.5" | CWM-R1620-4k |
| WR-963036 | Rectangle | 96" | 30" | 36" | 164 | 55.6 | 93" x 27" | 95.5" x 29.5" | CWM-R1620-4k |
| WR-963042 | Rectangle | 96" | 30" | 42" | 183 | 65.1 | 93" x 27" | 95.5" x 29.5" | CWM-R1620-4k |
| WR-963618 | Rectangle | 96" | 36" | 18" | 115 | 33.2 | 91" x 31" | 95.5" x 35.5" | CWM-R1614-4k |
| WR-963624 | Rectangle | 96" | 36" | 24" | 136 | 43.9 | 91" x 31" | 95.5" x 35.5" | CWM-R1620-4k |
| WR-963630 | Rectangle | 96" | 36" | 30" | 156 | 55.3 | 91" x 31" | 95.5" x 35.5" | CWM-R1620-4k |
| WR-963636 | Rectangle | 96" | 36" | 36" | 177 | 66.6 | 91" x 31" | 95.5" x 35.5" | CWM-R1620-4k |
| WR-963642 | Rectangle | 96" | 36" | 42" | 198 | 78 | 91" x 31" | 95.5" x 35.5" | CWM-R1620-4k |
| WR-964818 | Rectangle | 96" | 48" | 18" | 137 | 44.4 | 91" x 43" | 95.5" x 47.5" | CWM-R1614-4k |

Wilshire Planters FRP Rectangle & Square

- Lightweight fiberglass
- Available in three standard textures
- Huge range of sizes
- Drain holes upon request or installed in field

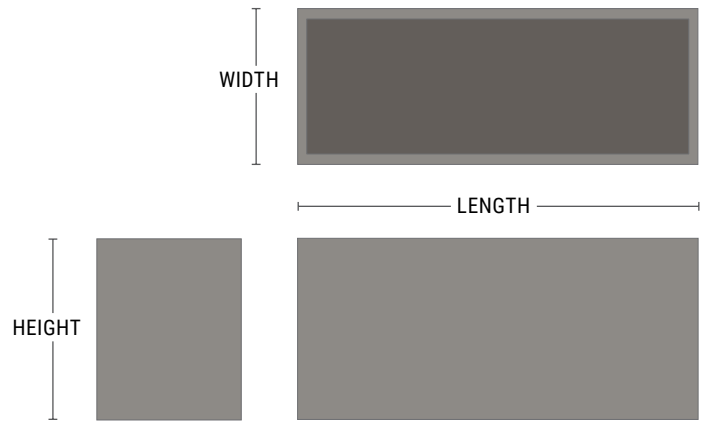

| PRODUCT | SHAPE | LENGTH | WIDTH | HEIGHT | WEIGHT (LBS.) | VOLUME (CUBIC FT.) | INTERIOR TOP | INTERIOR BOTTOM | IRRIGATION |
|------------|-----------|--------|-------|--------|---------------|--------------------|--------------|-----------------|------------------------------------|
| WR-964824 | Rectangle | 96" | 48" | 24" | 159 | 58.4 | 91" x 43" | 95.5" x 47.5" | CWM-R1614-4k |
| WR-964830 | Rectangle | 96" | 48" | 30" | 182 | 73.6 | 91" x 43" | 95.5" x 47.5" | CWM-R1620-4k |
| WR-964836 | Rectangle | 96" | 48" | 36" | 204 | 88.5 | 91" x 43" | 95.5" x 47.5" | CWM-R1620-4k |
| WR-964842 | Rectangle | 96" | 48" | 42" | 227 | 103.7 | 91" x 43" | 95.5" x 47.5" | CWM-R1620-4k |
| WR-1201012 | Rectangle | 120" | 10" | 12" | 65 | 7.8 | 117" x 7" | 119.5" x 9.5" | CWM-R1109-5k |
| WR-1201218 | Rectangle | 120" | 12" | 18" | 89 | 14.3 | 117" x 9" | 119.5" x 11.5" | CWM-R1114-5k |
| WR-1201236 | Rectangle | 120" | 12" | 36" | 151 | 28.4 | 117" x 9" | 119.5" x 11.5" | CWM-R1120-5k |
| WR-1201818 | Rectangle | 120" | 18" | 18" | 102 | 21.6 | 117" x 15" | 119.5" x 17.5" | CWM-R1114-4k/5k or CWM-R1614-4k/5k |
| WR-1201824 | Rectangle | 120" | 18" | 24" | 123 | 28.9 | 117" x 15" | 119.5" x 17.5" | CWM-R1620-5k |
| WR-1201830 | Rectangle | 120" | 18" | 30" | 145 | 33.7 | 117" x 15" | 119.5" x 17.5" | CWM-R1620-5k |
| WR-1201836 | Rectangle | 120" | 18" | 36" | 166 | 42.6 | 117" x 15" | 119.5" x 17.5" | CWM-R1620-5k |
| WR-1202418 | Rectangle | 120" | 24" | 18" | 114 | 29 | 117" x 21" | 119.5" x 23.5" | CWM-R1614-5k |
| WR-1202424 | Rectangle | 120" | 24" | 24" | 137 | 37.7 | 117" x 21" | 119.5" x 23.5" | CWM-R1620-5k |
| WR-1202430 | Rectangle | 120" | 24" | 30" | 159 | 47.1 | 117" x 21" | 119.5" x 23.5" | CWM-R1620-5k |
| WR-1202436 | Rectangle | 120" | 24" | 36" | 182 | 58.4 | 117" x 21" | 119.5" x 23.5" | CWM-R1620-5k |
| WR-1202442 | Rectangle | 120" | 24" | 42" | 204 | 65.9 | 117" x 21" | 119.5" x 23.5" | CWM-R1620-5k |
| WR-1202424 | Rectangle | 120" | 24" | 24" | 137 | 37.7 | 117" x 21" | 119.5" x 23.5" | CWM-R1620-5k |
| WR-1203018 | Rectangle | 120" | 30" | 18" | 127 | 35.6 | 117" x 27" | 119.5" x 29.5" | CWM-R1614-5k |
| WR-1203024 | Rectangle | 120" | 30" | 24" | 150 | 45.7 | 117" x 27" | 119.5" x 29.5" | CWM-R1620-5k |
| WR-1203030 | Rectangle | 120" | 30" | 30" | 173 | 57.6 | 117" x 27" | 119.5" x 29.5" | CWM-R1620-5k |

Wilshire Planters FRP Rectangle & Square

- Lightweight fiberglass
- Available in three standard textures
- Huge range of sizes
- Drain holes upon request or installed in field

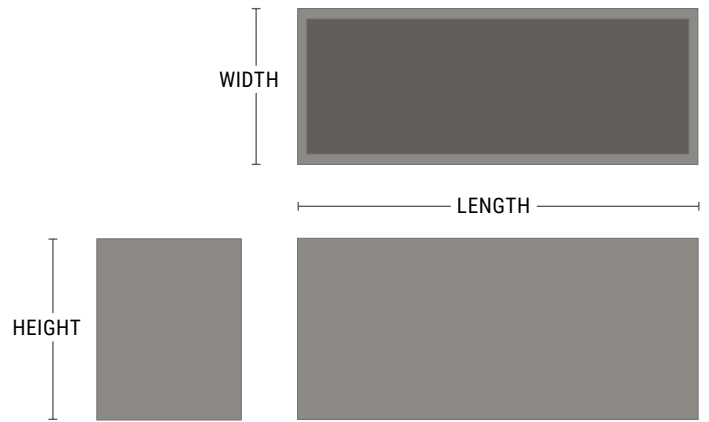

| PRODUCT | SHAPE | LENGTH | WIDTH | HEIGHT | WEIGHT (LBS.) | VOLUME (CUBIC FT.) | INTERIOR TOP | INTERIOR BOTTOM | IRRIGATION |
|------------|-----------|--------|-------|--------|---------------|--------------------|--------------|-----------------|--------------|
| WR-1203036 | Rectangle | 120" | 30" | 36" | 197 | 69.5 | 117" x 27" | 119.5" x 29.5" | CWM-R1620-5k |
| WR-1203042 | Rectangle | 120" | 30" | 42" | 220 | 81.4 | 117" x 27" | 119.5" x 29.5" | CWM-R1620-5k |
| WR-1203618 | Rectangle | 120" | 36" | 18" | 139 | 41.6 | 115" x 31" | 119.5" x 35.5" | CWM-R1614-5k |
| WR-1203624 | Rectangle | 120" | 36" | 24" | 164 | 54.9 | 115" x 31" | 119.5" x 35.5" | CWM-R1620-5k |
| WR-1203630 | Rectangle | 120" | 36" | 30" | 188 | 69.2 | 115" x 31" | 119.5" x 35.5" | CWM-R1620-5k |
| WR-1203636 | Rectangle | 120" | 36" | 36" | 212 | 83.5 | 115" x 31" | 119.5" x 35.5" | CWM-R1620-5k |
| WR-1203642 | Rectangle | 120" | 36" | 42" | 237 | 97.7 | 115" x 31" | 119.5" x 35.5" | CWM-R1620-5k |



Wilshire Planters FRP Round

The addition of glass fibers turns ordinary resin into a superhero! The Wilshire Planters made from FRP are the lightest among the collection yet can retain moisture-laden soil without deforming. Surface-applied textures add scratch-resistance and are available in stock or custom colors. Available in 18 colors and three textures.

Wilshire Planters, FRP Round

WILSHIRE PLANTERS, FRP ROUND

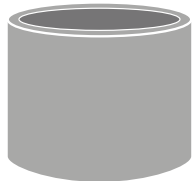

Round

THE COMPLETE WILSHIRE COLLECTION

For additional shapes and materials, visit tournesol.com/collections/wilshire

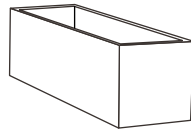

Rectangle

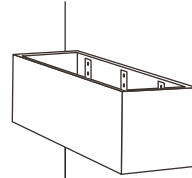

Hanging Box

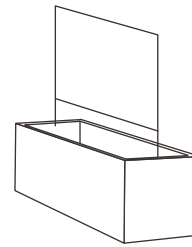

Trellis, Laser-Cut Screen



Square

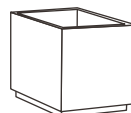

Toe Kick

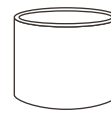

Round



Round with Toe Kick

OPTIONS

Standard Wilshire Planters can be modified with a broad array of options without incurring custom charges. Options are limited to those products that can support them. Speak to a Tournesol Advisor to discuss which options will work with your project.



Irrigation



Change Dimension



Casters



TourneSeal



Drain Holes



Matching Saucer



False Bottom



Tie Downs



Bottom Reinforcement



Lift Channels



Custom Color

Wilshire Planters FRP Round

- Lightweight fiberglass
- Available in three standard textures
- Drain holes upon request or installed in field

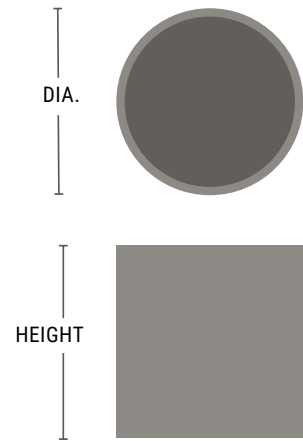

| PRODUCT | SHAPE | DIA. | HEIGHT | WEIGHT (LBS.) | VOLUME (CUBIC FT.) | INTERIOR TOP | INTERIOR BOTTOM | IRRIGATION |
|----------|-------|---------|--------|---------------|--------------------|--------------|-----------------|----------------------|
| WS-1800F | Round | 18" dia | 20" | 19 | 2.5 | 15" dia | 14.5" dia | CWC-1216 |
| WS-2400F | Round | 24" dia | 24" | 31 | 6 | 21" dia | 20.5" dia | CWC-1600/CWM-1114-2k |
| WS-3000F | Round | 30" dia | 27" | 44 | 11 | 27" dia | 25.5" dia | CWC-2400/CWM-1720-2k |
| WS-3600F | Round | 36" dia | 30" | 59 | 17 | 31.5" dia | 31.5" dia | CWM-1720-3k |
| WS-4200F | Round | 42" dia | 33" | 77 | 26 | 37.5" dia | 37.5" dia | CWM-1720-3k |
| WS-4800F | Round | 48" dia | 36" | 96 | 35.5 | 43.5" dia | 43.5" dia | CWM-2920-3k |
| WS-6000F | Round | 60" dia | 36" | 128 | 55.5 | 55.5" dia | 55.5" dia | CWM-2920-4k |
| WS-7200F | Round | 72" dia | 42" | 180 | 94.5 | 67" dia | 67.5" dia | CWM-2920-5k |



Wilshire Planters FRP Square with Toe Kick

The addition of glass fibers turns ordinary resin into a superhero! The Wilshire Planters made from FRP are the lightest among the collection yet can retain moisture-laden soil without deforming. Surface-applied textures add scratch-resistance and are available in stock or custom colors. Available in 18 colors and three textures.

Wilshire Planters, FRP Square with Toe Kick

WILSHIRE PLANTERS, FRP SQUARE WITH TOE KICK

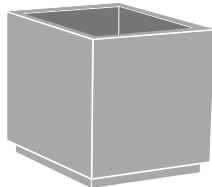

Square with Toe Kick

THE COMPLETE WILSHIRE COLLECTION

For additional shapes and materials, visit tournesol.com/collections/wilshire

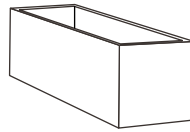

Rectangle

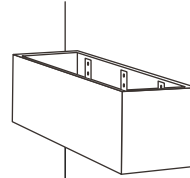

Hanging Box

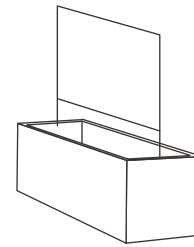

Trellis, Laser-Cut Screen

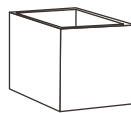

Square

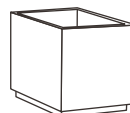

Toe Kick

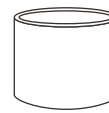

Round



Round with Toe Kick

OPTIONS

Standard Wilshire Planters can be modified with a broad array of options without incurring custom charges. Options are limited to those products that can support them. Speak to a Tournesol Advisor to discuss which options will work with your project.



Irrigation



Change Dimension



Accessory Pockets



Scoops



Tourneseal



Drain Holes



Matching Saucer



Custom Color

Wilshire Planters FRP Square with Toe Kick

- Lightweight fiberglass
- Available in three standard textures
- Toe kick visually lifts planter
- Toe kick can accommodate lighting
- Drain holes upon request or installed in field

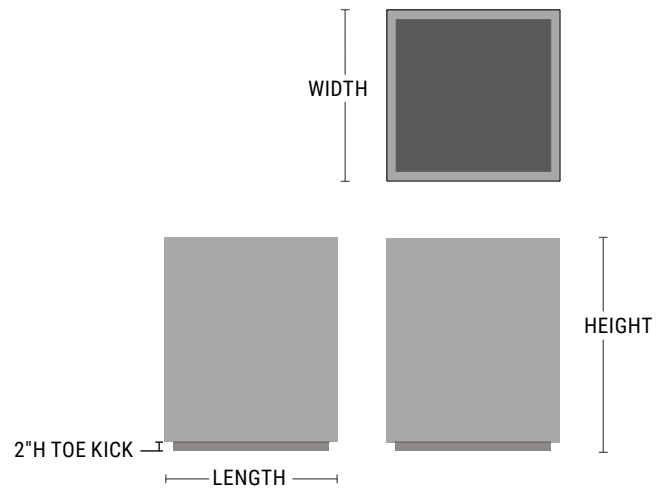

| PRODUCT | SHAPE | LENGTH | WIDTH | HEIGHT | WEIGHT (LBS.) | VOLUME (CUBIC FT.) | INTERIOR TOP | INTERIOR BOTTOM | IRRIGATION |
|----------|-----------------|--------|-------|--------|---------------|--------------------|--------------|-----------------|------------------------|
| WR-1800 | Toe Kick Square | 18" | 18" | 20" | 26 | 3.4 | 15" x 15" | 14.5" x 14.5" | - |
| WRT-1800 | Toe Kick Square | 18" | 18" | 30" | 36 | 5.1 | 15" x 15" | 17.5" x 17.5" | CWC-R1100 |
| WR-2400 | Toe Kick Square | 24" | 24" | 24" | 42 | 8 | 21" x 21" | 20.5" x 20.5" | CWC-R1850/CWM-R1114-2k |
| WRT-2400 | Toe Kick Square | 24" | 24" | 48" | 72 | 15.1 | 21" x 21" | 23.5" x 23.5" | CWC-R1850 |
| WR-3000 | Toe Kick Square | 30" | 30" | 27" | 59 | 14 | 27" x 27" | 25.5" x 25.5" | CWM-R1620-2k |
| WRT-3000 | Toe Kick Square | 30" | 30" | 54" | 103 | 26.6 | 27" x 27" | 29.5" x 29.5" | CWM-R1620-2k-CRT |
| WR-3600 | Toe Kick Square | 36" | 36" | 30" | 80 | 22 | 31" x 31" | 31.5" x 31.5" | CWM-R1620-2k |
| WR-4200 | Toe Kick Square | 42" | 42" | 36" | 110 | 37 | 37" x 37" | 43.5" x 43.5" | CWM-1720-4K |
| WR-4824 | Toe Kick Square | 48" | 48" | 24" | 79 | 29 | 43" x 43" | 43.5" x 43.5" | CWM-R2914-2k |
| WR-4800 | Toe Kick Square | 48" | 48" | 36" | 130 | 48 | 43" x 43" | 43.5" x 43.5" | CWM-R2920-2k |
| WR-6000 | Toe Kick Square | 60" | 60" | 42" | 186 | 80 | 55" x 55" | 55.5" x 55.5" | CWM-R2920-4k |
| WR-7200 | Toe Kick Square | 72" | 72" | 42" | 234 | 120 | 67" x 67" | 67.5" x 67.5" | CWM-R2020-4k-E |



Wilshire Planters FRP Round with Toe Kick

The addition of glass fibers turns ordinary resin into a superhero! The Wilshire Planters made from FRP are the lightest among the collection yet can retain moisture-laden soil without deforming. Surface-applied textures add scratch-resistance and are available in stock or custom colors. Available in 18 colors and three textures.

Wilshire Planters, FRP Round with Toe Kick

WILSHIRE PLANTERS, FRP ROUND WITH TOE KICK

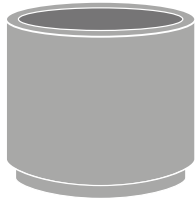

Round with Toe Kick

THE COMPLETE WILSHIRE COLLECTION

For additional shapes and materials, visit tournesol.com/collections/wilshire

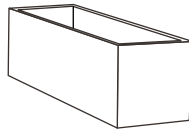

Rectangle

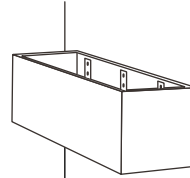

Hanging Box

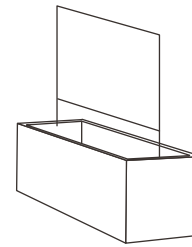

Trellis, Laser-Cut Screen

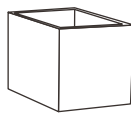

Square

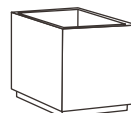

Toe Kick

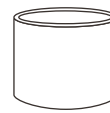

Round



Round with Toe Kick

OPTIONS

Standard Wilshire Planters can be modified with a broad array of options without incurring custom charges. Options are limited to those products that can support them. Speak to a Tournesol Advisor to discuss which options will work with your project.



Irrigation



Change Dimension



TourneSeal



Drain Holes



Matching Saucer



Custom Color

Wilshire Planters FRP Round with Toe Kick

- Lightweight fiberglass
- Available in three standard textures
- Toe kick visually lifts planter
- Toe kick can accommodate lighting
- Drain holes upon request or installed in field

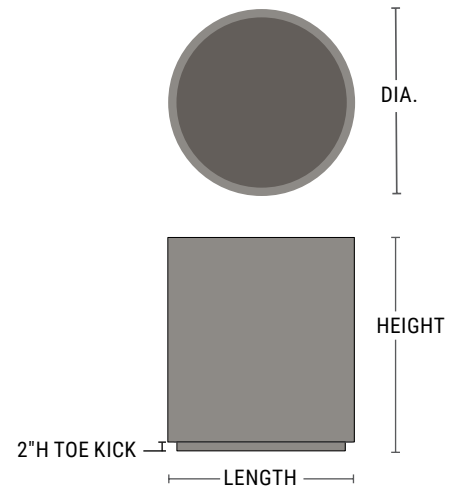

| PRODUCT | SHAPE | DIA. | HEIGHT | WEIGHT (LBS.) | VOLUME (CUBIC FT.) | INTERIOR TOP | INTERIOR BOTTOM | IRRIGATION |
|----------|----------------|---------|--------|---------------|--------------------|--------------|-----------------|----------------------|
| WS-1800 | Toe Kick Round | 18" dia | 20" | 19 | 2.5 | 15" dia | 14.5" dia | CWC-1216 |
| WST-1800 | Toe Kick Round | 18" dia | 30" | 26 | 4.1 | 15" x 15" | 17.5" x 17.5" | CWI-1200 |
| WS-2400 | Toe Kick Round | 24" dia | 24" | 31 | 6 | 21" dia | 20.5" dia | CWC-1600/CWM-1114-2k |
| WST-2400 | Toe Kick Round | 24" dia | 48" | 54 | 11.9 | 21" x 21" | 23.5" x 23.5" | CWI-1700 |
| WS-3000 | Toe Kick Round | 30" dia | 27" | 44 | 11 | 27" dia | 25.5" dia | CWC-2400/CWM-1720-2k |
| WST-3000 | Toe Kick Round | 30" dia | 54" | 77 | 21 | 27" x 27" | 29.5" x 29.5" | CWI-2200 |
| WS-3600 | Toe Kick Round | 36" dia | 30" | 59 | 17 | 31.5" dia | 31.5" dia | CWM-1720-3k |
| WS-4200 | Toe Kick Round | 42" dia | 33" | 77 | 26 | 37.5" dia | 37.5" dia | CWM-1720-3k |
| WS-4800 | Toe Kick Round | 48" dia | 36" | 96 | 35.5 | 43.5" dia | 43.5" dia | CWM-2920-3k` |
| WS-6000 | Toe Kick Round | 60" dia | 36" | 128 | 55.5 | 55.5" dia | 55.5" dia | CWM-2920-4k |
| WS-7200 | Toe Kick Round | 72" dia | 42" | 180 | 94.5 | 67" dia | 67.5" dia | CWM-2920-5k |



Wilshire Planters FRP with Greenscreen® Trellis

An attractive, easy-to-install solution for creating privacy or hiding unattractive elements like building systems. Our lightweight FRP Fiberglass planter (available in all colors and textures) and Greenscreen® trellis, framed on top and sides, with vertical supports to fit in planter lip. Trellis available in various powder-coat colors.

Wilshire Planters, FRP with Greenscreen® Trellis

WILSHIRE PLANTERS FRP WITH GREENSCREEN® TRELLIS

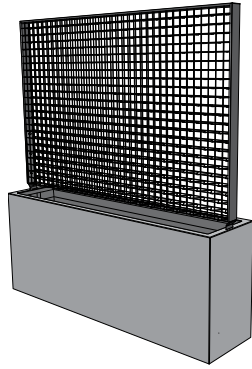

Planter with Trellis

THE COMPLETE WILSHIRE COLLECTION

For additional shapes and materials, visit tournesol.com/collections/wilshire

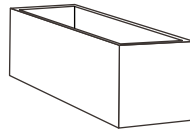

Rectangle

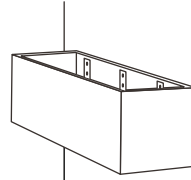

Hanging Box

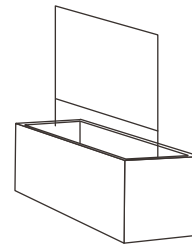

Trellis, Laser-Cut Screen

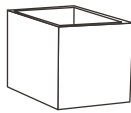

Square

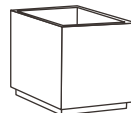

Toe Kick

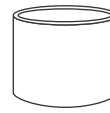

Round



Round with Toe Kick

OPTIONS

Standard Wilshire Planters can be modified with a broad array of options without incurring custom charges. Options are limited to those products that can support them. Speak to a Tournesol Advisor to discuss which options will work with your project.



Irrigation



Change Dimension



Accessory Pockets



TourneSeal



Drain Holes



Matching Saucer



Custom Color

Wilshire Planters, FRP with Greenscreen® Trellis

- Durable, lightweight FRP planter with powder-coated Greenscreen® trellis. 2"W x 2"L x 3"D grid.
- Trellis vertical supports fit into planter lip and are secured with discrete stainless-steel fasteners.
- Trellis is framed on top and sides and extends to planter edge so adjacent planters form a seamless trellis wall.
- Select a Greenscreen Trellis color in addition to a FRP color and texture. Drain holes available upon request.

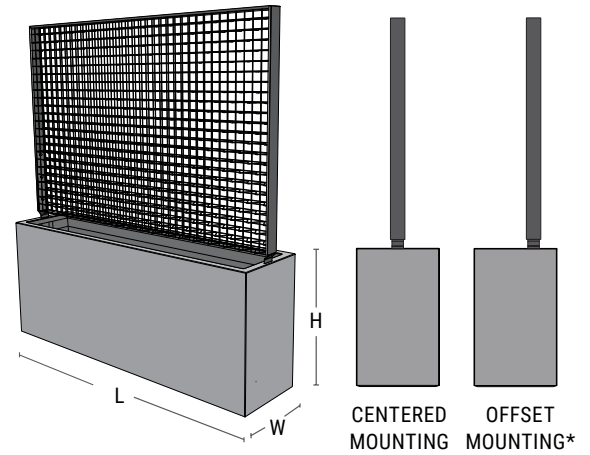

* Add "-X" after product number to indicate optional offset mounting.

| PRODUCT | LENGTH | WIDTH | HEIGHT OF PLANTER | TOTAL HEIGHT WITH TRELLIS | WEIGHT (LBS.) | VOLUME (CUBIC FT.) | IRRIGATION |
|---------------|--------|-------|-------------------|---------------------------|---------------|--------------------|--------------|
| WX2-481824-74 | 48" | 18" | 24" | 74" | 101 | 11.5 | CWM-R1620-2k |
| WX2-481830-80 | 48" | 18" | 30" | 80" | 111 | 17.3 | CWM-R1620-2k |
| WX2-481836-86 | 48" | 18" | 36" | 86" | 122 | 23.1 | CWM-R1620-2k |
| WX2-482424-74 | 48" | 24" | 24" | 74" | 109 | 13.5 | CWM-R1620-2k |
| WX2-482430-80 | 48" | 24" | 30" | 80" | 121 | 20.2 | CWM-R1620-2k |
| WX2-482436-86 | 48" | 24" | 36" | 86" | 132 | 27 | CWM-R1620-2k |
| WX2-721824-74 | 72" | 18" | 24" | 74" | 133 | 13.5 | CWM-R1620-3k |
| WX2-721830-80 | 72" | 18" | 30" | 80" | 148 | 25.5 | CWM-R1620-3k |
| WX2-721836-86 | 72" | 18" | 36" | 86" | 122 | 34 | CWM-R1620-3k |
| WX2-722424-74 | 72" | 24" | 24" | 74" | 144 | 15 | CWM-R1620-3k |
| WX2-722430-80 | 72" | 24" | 30" | 80" | 159 | 22.6 | CWM-R1620-3k |
| WX2-722436-86 | 72" | 24" | 36" | 86" | 175 | 30.1 | CWM-R1620-3k |
| WX2-961824-74 | 96" | 18" | 24" | 74" | 166 | 18.8 | CWM-R1620-4k |
| WX2-961830-80 | 96" | 18" | 30" | 80" | 185 | 28.2 | CWM-R1620-3k |
| WX2-961836-86 | 96" | 18" | 36" | 86" | 203 | 37.7 | CWM-R1620-4k |
| WX2-962424-74 | 96" | 24" | 24" | 74" | 178 | 23.3 | CWM-R1620-4k |
| WX2-962430-80 | 96" | 24" | 30" | 80" | 198 | 35 | CWM-R1620-4k |
| WX2-962436-86 | 96" | 24" | 36" | 86" | 218 | 46.7 | CWM-R1620-4k |



Wilshire Planters FRP with Laser-Cut Screen

An attractive, easy-to-install solution for creating privacy or hiding unattractive elements such as building systems. Available in lightweight GFRC concrete or FRP Fiberglass in all colors and textures. Steel laser-cut screen is available in all powder-coat finishes.

Wilshire Planters, FRP with Laser-Cut Screen

WILSHIRE PLANTERS FRP WITH LASER-CUT SCREEN

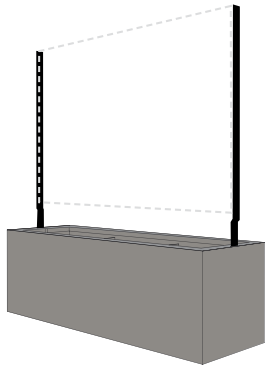

Planter with Laser-Cut Screen

THE COMPLETE WILSHIRE COLLECTION

For additional shapes and materials, visit tournesol.com/collections/wilshire

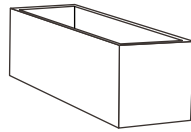

Rectangle

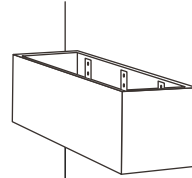

Hanging Box

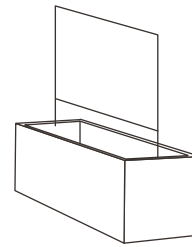

Trellis, Laser-Cut Screen

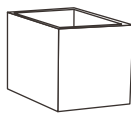

Square

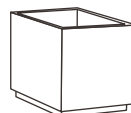

Toe Kick

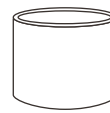

Round



Round with Toe Kick

OPTIONS

Standard Wilshire Planters can be modified with a broad array of options without incurring custom charges. Options are limited to those products that can support them. Speak to a Tournesol Advisor to discuss which options will work with your project.



Irrigation



Change Dimension



Accessory Pockets



TourneSeal



Drain Holes



Matching Saucer



Custom Color

Wilshire Planters FRP with Laser-Cut Screen

Select one of the patterns shown at right or submit your own artwork.

Available in powder-coated or weathering steel.

Shown at right in 48"L x 48"H



48"L x 48"H

**WX-48 INCLUDES ONE
48"L x 48"H LASER-CUT SCREEN.**



72"L x 48"H

**WX-72 INCLUDES ONE
72"L x 48"H LASER-CUT SCREEN.**



96"L x 48"H

**WX-96 INCLUDES ONE
96"L x 48"H LASER-CUT SCREEN.**

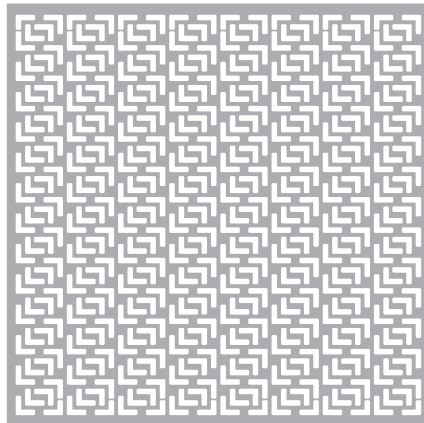

Pattern 2 - 30% Open

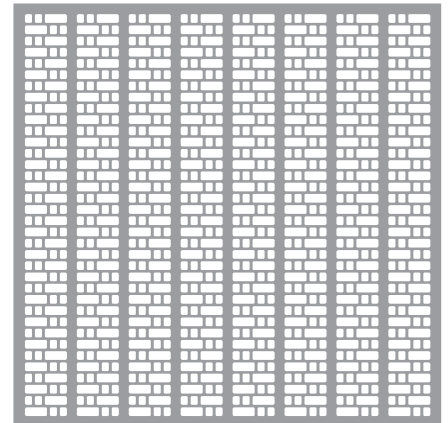

Pattern 3 - 32% Open

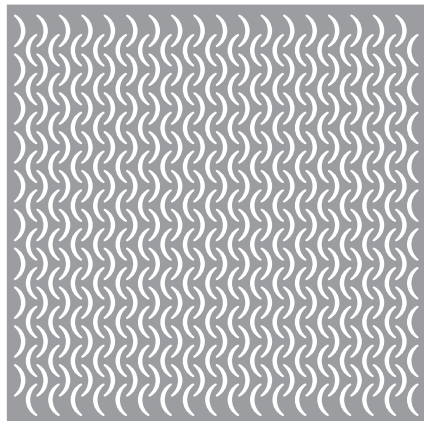

Pattern 4 - 20% Open

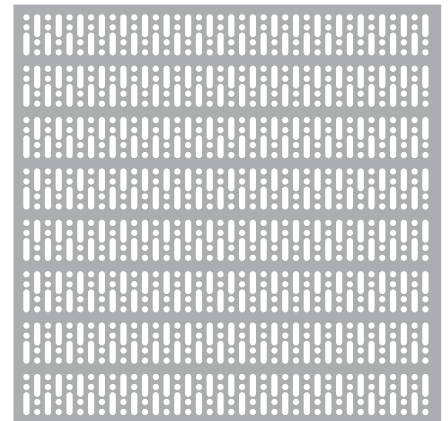

Pattern 6 - 25% Open

CUSTOM PATTERN OPTIONS

| Part No. | Description |
|---------------|---|
| WXS-LC | Custom laser-cut screen charge, varies by design and size |
| WXS Setup CAD | One-time setup charge for laser-cut screens, customer to provide CAD drawings |
| WXS Setup PDF | One-time setup charge for laser-cut screens, customer to provide PDF drawings |

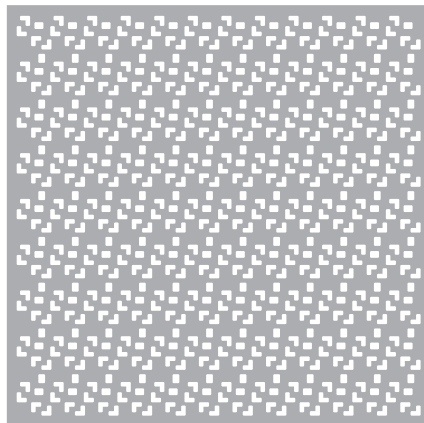

Pattern 7 - 17% Open

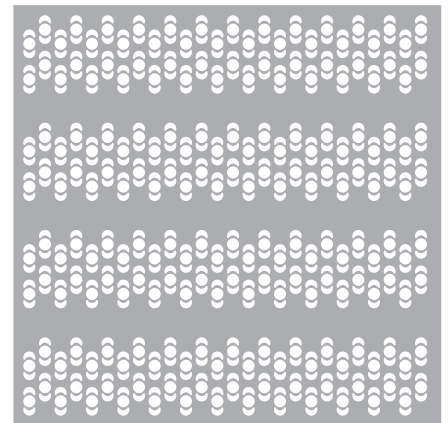

Pattern 8 - 22% Open

Wilshire Planters FRP with Laser-Cut Screen

- Lightweight fiberglass
- Integrated privacy screen
- Custom screen designs possible
- Hidden support brackets
- Drain holes upon request or installed in field

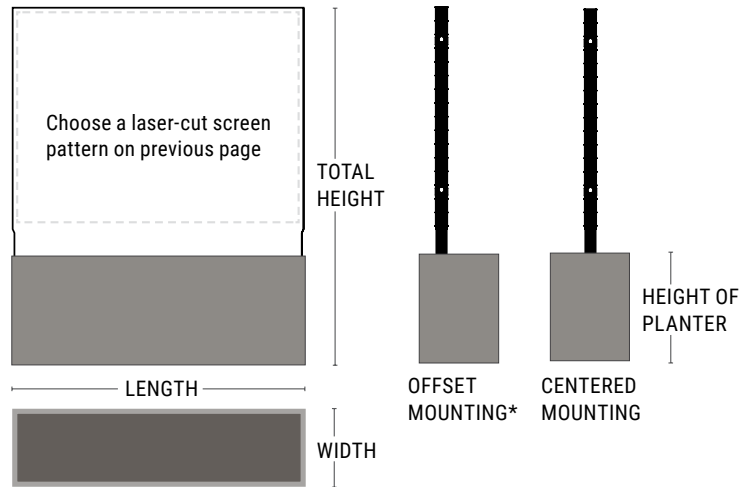

* When specifying offset mounting, add "-X" after product number. Example: WX-481824-74 is centered mounting, and WX-481824-74-X is offset mounting.

| PRODUCT | LENGTH | WIDTH | HEIGHT OF PLANTER | TOTAL HEIGHT WITH SCREEN | WEIGHT (LBS.) | VOLUME (CUBIC FT.) | IRRIGATION | LASER-CUT SCREEN |
|--------------|--------|-------|-------------------|--------------------------|---------------|--------------------|--------------|--------------------------|
| WX-481824-74 | 48" | 18" | 24" | 74" | 146 | 11.5 | CWM-R1620-2k | Options on previous page |
| WX-481830-80 | 48" | 18" | 30" | 80" | 160 | 17.3 | CWM-R1620-2k | Options on previous page |
| WX-481836-86 | 48" | 18" | 36" | 86" | 176 | 23.1 | CWM-R1620-2k | Options on previous page |
| WX-482424-74 | 48" | 24" | 24" | 74" | 154 | 13.5 | CWM-R1620-2k | Options on previous page |
| WX-482430-80 | 48" | 24" | 30" | 80" | 169 | 20.2 | CWM-R1620-2k | Options on previous page |
| WX-482436-86 | 48" | 24" | 36" | 86" | 186 | 27 | CWM-R1620-2k | Options on previous page |
| WX-721824-74 | 72" | 18" | 24" | 74" | 204 | 13.5 | CWM-R1620-3k | Options on previous page |
| WX-721830-80 | 72" | 18" | 30" | 80" | 224 | 25.5 | CWM-R1620-3k | Options on previous page |
| WX-721836-86 | 72" | 18" | 36" | 86" | 248 | 34 | CWM-R1620-3k | Options on previous page |
| WX-722424-74 | 72" | 24" | 24" | 74" | 214 | 15 | CWM-R1620-3k | Options on previous page |
| WX-722430-80 | 72" | 24" | 30" | 80" | 236 | 22.6 | CWM-R1620-3k | Options on previous page |
| WX-722436-86 | 72" | 24" | 36" | 86" | 262 | 30.1 | CWM-R1620-3k | Options on previous page |
| WX-961824-74 | 96" | 18" | 24" | 74" | 259 | 18.8 | CWM-R1620-4k | Options on previous page |
| WX-961830-80 | 96" | 18" | 30" | 80" | 286 | 28.2 | CWM-R1620-3k | Options on previous page |
| WX-961836-86 | 96" | 18" | 36" | 86" | 317 | 37.7 | CWM-R1620-4k | Options on previous page |
| WX-962424-74 | 96" | 24" | 24" | 74" | 272 | 23.3 | CWM-R1620-4k | Options on previous page |
| WX-962430-80 | 96" | 24" | 30" | 80" | 300 | 35 | CWM-R1620-4k | Options on previous page |
| WX-962436-86 | 96" | 24" | 36" | 86" | 334 | 46.7 | CWM-R1620-4k | Options on previous page |



Wilshire Planters FRP Hanging Box

With a lightweight fiberglass planter, pre-engineered brackets, and easy-to-use mount template, we have a complete hanging box system for you! These planter boxes are the ultimate wall-mounted large planter solution.

Wilshire Planters, FRP Hanging Box

WILSHIRE PLANTERS, FRP HANGING BOX

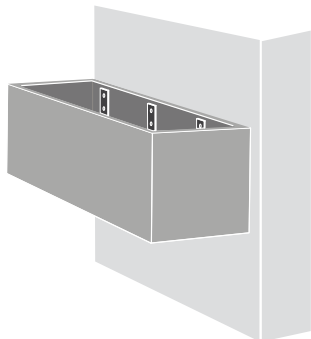

Hanging Box

THE COMPLETE WILSHIRE COLLECTION

For additional shapes and materials, visit tournesol.com/collections/wilshire

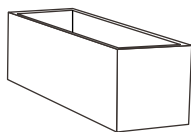

Rectangle

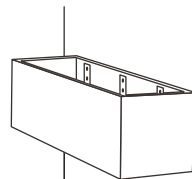

Hanging Box

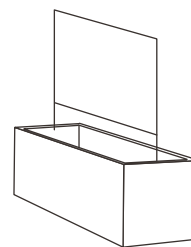

Trellis, Laser-Cut Screen



Square

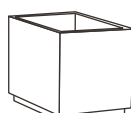

Toe Kick

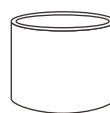

Round



Round with Toe Kick

OPTIONS

Standard Wilshire Planters can be modified with a broad array of options without incurring custom charges. Options are limited to those products that can support them. Speak to a Tournesol Advisor to discuss which options will work with your project.



Irrigation



Change Dimension



TourneSeal



Drain Holes

Wilshire Planters FRP Hanging Box

- Tournesol's original commercial hanging box system
- Engineered for facade installation
- Designed for easy mounting & structural integrity
- Reinforced lightweight FRP planter
- Powder-coated steel brackets
- Stainless steel mounting studs
- In production for 20 years, thousands of units installed
- Anchoring hardware not included and is at the discretion of the contractor or project engineer
- Aluminum anchor templates are available
- Works well with our irrigation modules for low maintenance.

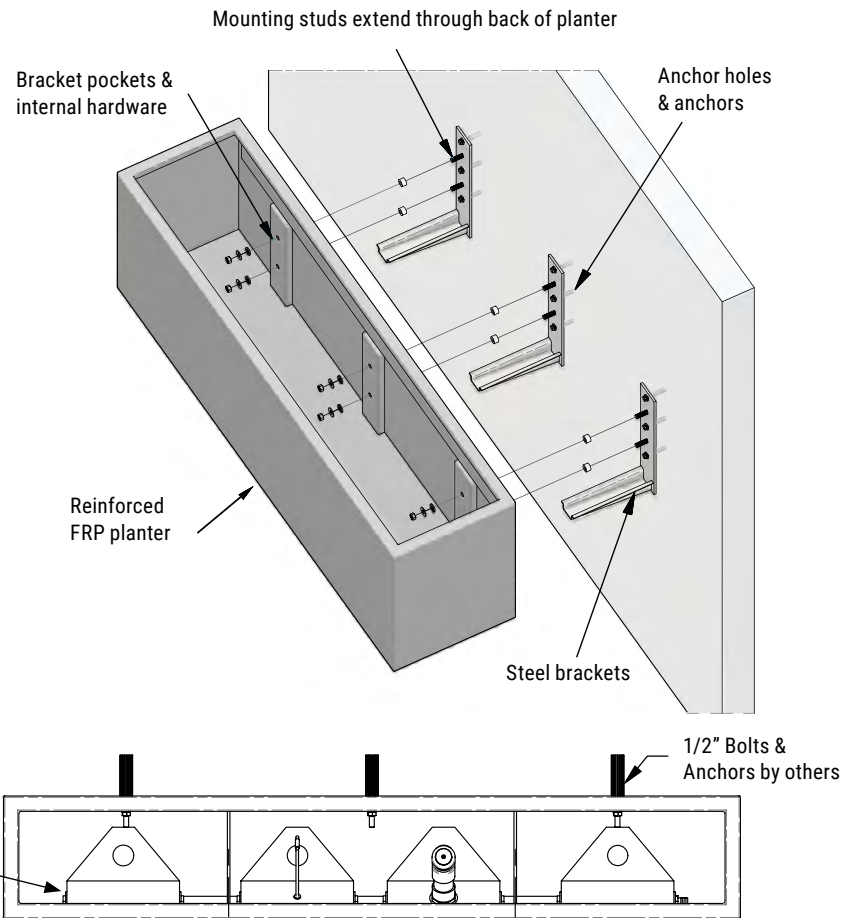

| PRODUCT | SHAPE | LENGTH | WIDTH | HEIGHT | WEIGHT (LBS.) | VOLUME (CUBIC FT.) | NUMBER OF BULKHEADS | NUMBER OF BRACKETS | IRRIGATION |
|------------|-----------|--------|-------|--------|---------------|--------------------|---------------------|--------------------|--------------|
| WB-1012-24 | Rectangle | 24" | 10" | 12" | 35 lbs | 1.6 cu. ft. | 0 | 2 | CWM-R1109-MS |
| WB-1218-24 | Rectangle | 24" | 12" | 18" | 46 lbs | 3 cu. ft. | 0 | 2 | CWM-R1114-MS |
| WB-1824-24 | Rectangle | 24" | 18" | 24" | 62 lbs | 6 cu. ft. | 0 | 2 | CWM-R2020-MS |
| WB-1012-36 | Rectangle | 36" | 10" | 12" | 40 lbs | 2.5 cu. ft. | 0 | 2 | CWM-R1109-2k |
| WB-1218-36 | Rectangle | 36" | 12" | 18" | 56 lbs | 4.5 cu. ft. | 0 | 2 | CWM-R1114-2k |
| WB-1824-36 | Rectangle | 36" | 18" | 24" | 72 lbs | 9 cu. ft. | 0 | 2 | CWM-R2020-MS |
| WB-1012-48 | Rectangle | 48" | 10" | 12" | 45 lbs | 3.3 cu. ft. | 0 | 2 | CWM-R1109-3k |
| WB-1218-48 | Rectangle | 48" | 12" | 18" | 61 lbs | 6 cu. ft. | 1 | 2 | CWM-R1114-3k |
| WB-1824-48 | Rectangle | 48" | 18" | 24" | 82 lbs | 12 cu. ft. | 1 | 2 | CWM-R1620-2k |
| WB-1012-60 | Rectangle | 60" | 10" | 12" | 50 lbs | 4.2 cu. ft. | 2 | 3 | CWM-R1109-3k |
| WB-1218-60 | Rectangle | 60" | 12" | 18" | 80 lbs | 7.5 cu. ft. | 2 | 3 | CWM-R1114-3k |
| WB-1824-60 | Rectangle | 60" | 18" | 24" | 108 lbs | 15 cu. ft. | 1 | 3 | CWM-R1620-2k |

Wilshire Planters FRP Hanging Box

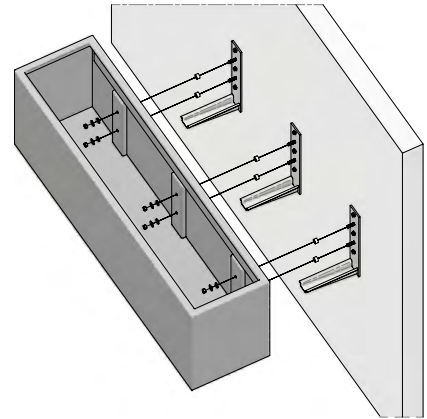

- Tournesol's original commercial hanging box system
- Engineered for facade installation
- Designed for easy mounting & structural integrity
- Reinforced lightweight FRP planter
- Powder-coated steel brackets
- Stainless steel mounting studs
- In production for 20 years, thousands of units installed
- Anchoring hardware not included and is at the discretion of the contractor or project engineer
- Aluminum anchor templates are available
- Works well with our irrigation modules for low maintenance.

| PRODUCT | SHAPE | LENGTH | WIDTH | HEIGHT | WEIGHT (LBS.) | VOLUME (CUBIC FT.) | NUMBER OF BULKHEADS | NUMBER OF BRACKETS | IRRIGATION |
|-------------|-----------|--------|-------|--------|---------------|--------------------|---------------------|--------------------|-----------------------------|
| WB-1012-72 | Rectangle | 72" | 10" | 12" | 55 lbs | 5 cu. ft. | 2 | 3 | CWM-R1109-4k |
| WB-1218-72 | Rectangle | 72" | 12" | 18" | 90 lbs | 9 cu. ft. | 2 | 3 | CWM-R1114-4k |
| WB-1824-72 | Rectangle | 72" | 18" | 24" | 118 lbs | 18 cu. ft. | 2 | 3 | CWM-R1620-3k |
| WB-1012-96 | Rectangle | 96" | 10" | 12" | 85 lbs | 6.7 cu. ft. | 2 | 4 | CWM-R1109-5k |
| WB-1218-96 | Rectangle | 96" | 12" | 18" | 125 lbs | 12 cu. ft. | 2 | 4 | CWM-R1114-5k |
| WB-1824-96 | Rectangle | 96" | 18" | 24" | 154 lbs | 24 cu. ft. | 3 | 4 | CWM-R1620-4k |
| WB-1012-120 | Rectangle | 120" | 10" | 12" | 105 lbs | 8.3 cu. ft. | 3 | 5 | CWM-R1109-3k + CWM-R1109-4k |
| WB-1218-120 | Rectangle | 120" | 12" | 18" | 148 lbs | 15 cu. ft. | 4 | 5 | CWM-R1114-3k + CWM-R1114-4k |
| WB-1824-120 | Rectangle | 120" | 18" | 24" | 190 lbs | 30 cu. ft. | 4 | 5 | CWM-R1620-5k |

HANGING BOX TEMPLATE

Aluminum and plastic template assists in correct placement of anchor holes.

| PRODUCT | DESCRIPTION |
|-------------|---|
| WBT-1012-XX | Drilling template for -1012 size Wilshire Box. Order by length (XX=# of inches) - Aluminum and plastic. |
| WBT-1218-XX | Drilling template for -1218 size Wilshire Box. Order by length (XX=# of inches) - Aluminum and plastic. |
| WBT-1824-XX | Drilling template for -1824 size Wilshire Box. Order by length (XX=# of inches) - Aluminum and plastic. |



Wilshire Planters Aluminum Rectangle & Square

Wilshire Powder-Coated Aluminum Planters are an environmentally friendly solution. Marine-grade aluminum with welded stiffeners is used to produce planters with the strength of steel but 40-60% of the weight.

Wilshire Planters, Aluminum Rectangle & Square

WILSHIRE PLANTERS, ALUMINUM RECTANGLES & SQUARES

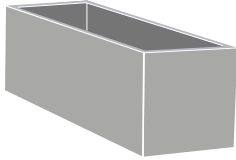

Rectangle

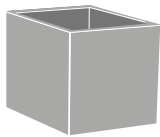

Square

THE COMPLETE WILSHIRE COLLECTION

For additional shapes and materials, visit tournesol.com/collections/wilshire

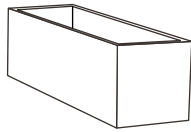

Rectangle

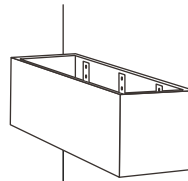

Hanging Box

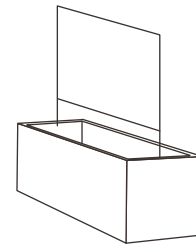

Trellis, Laser-Cut Screen

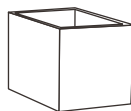

Square

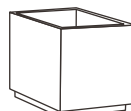

Toe Kick

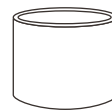

Round



Round with Toe Kick

OPTIONS

Standard Wilshire Planters can be modified with a broad array of options without incurring custom charges. Options are limited to those products that can support them. Speak to a Tournesol Advisor to discuss which options will work with your project.



Irrigation



Change Dimension



Accessory Pockets



Scoops



Casters



Drain Holes



Toe Kick



False Bottom



Tie Downs

Wilshire Planters, Aluminum Rectangle & Square

POWDER-COATED ALUMINUM

Following fully welded fabrication, Wilshire Aluminum Planters are dry steam washed and pretreated with a closed loop, environmentally friendly zirconium solution before a zinc-free epoxy primer and AAMA 2604 polyester powder-coat is applied.

TOP LIP

Wilshire Aluminum Planters come with a standard lip return.

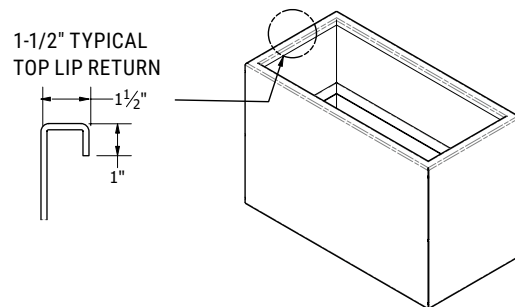

BASE OPTION

Wilshire Planters are available with a toe kick option.

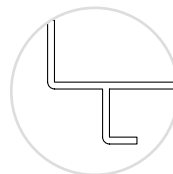

WWR-RE

Toe kick option
2"H bottom reveal

DRAINAGE

Drain Holes: Standard drain holes are 1-5/8" diameter, made free-of-charge at the factory.

Wilshire Planters Aluminum Rectangle & Square

- 100% recyclable marine-grade aluminum
- Same strength as Wilshire Steel but weigh 40-60% less
- Engineered for strength with welded stiffeners
- Laser-cut & welded for consistent thickness and edge-detail at any scale
- Powder-coat over zinc-free epoxy primer

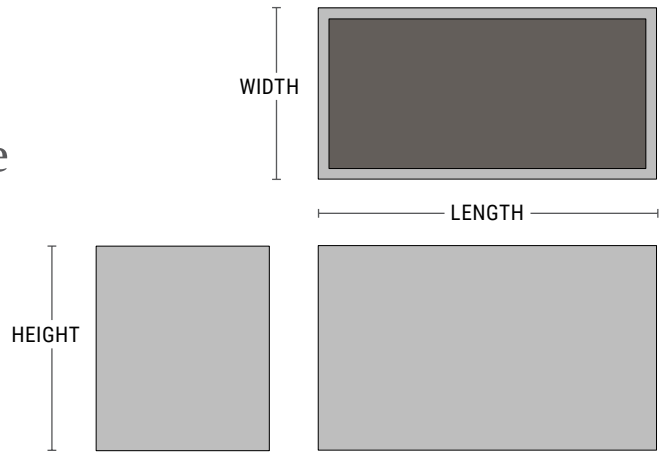

| PRODUCT | SHAPE | LENGTH | WIDTH | HEIGHT | WEIGHT (LBS.) | VOLUME (CUBIC FT.) | INTERIOR TOP | INTERIOR BOTTOM | IRRIGATION |
|--------------|-------------|--------|-------|--------|---------------|--------------------|--------------|-----------------|------------------------|
| WWR-AL1800 | Square | 18" | 18" | 20" | 29 | 3.4 | 15" x 15" | 14.5" x 14.5" | - |
| WVRT-AL1800 | Square Tall | 18" | 18" | 30" | 35 | 5.1 | 15" x 15" | 17.5" x 17.5" | CWC-R1100 |
| WWR-AL241012 | Rectangle | 24" | 10" | 12" | 16 | 1.5 | 21" x 7" | 23.5" x 9.5" | CWM-R1109-MS |
| WWR-AL241218 | Rectangle | 24" | 12" | 18" | 21 | 2.8 | 21" x 9" | 23.5" x 11.5" | CWM-R1114-MS |
| WWR-AL241236 | Rectangle | 24" | 12" | 36" | 43 | 5.6 | 21" x 9" | 23.5" x 11.5" | CWM-R1120-MS |
| WWR-AL241818 | Rectangle | 24" | 18" | 18" | 24 | 4.3 | 21" x 15" | 23.5" x 17.5" | CWM-R1114-MS |
| WWR-AL241824 | Rectangle | 24" | 18" | 24" | 38 | 5.7 | 21" x 15" | 23.5" x 17.5" | CWM-R1620-MS |
| WWR-AL241830 | Rectangle | 24" | 18" | 30" | 44 | 7 | 21" x 15" | 23.5" x 17.5" | CWM-R1620-MS |
| WWR-AL241836 | Rectangle | 24" | 18" | 36" | 50 | 8.4 | 21" x 15" | 23.5" x 17.5" | CWM-R1620-MS |
| WWR-AL242418 | Square | 24" | 24" | 18" | 37 | 5.7 | 21" x 21" | 23.5" x 23.5" | CWM-R1614-MS |
| WWR-AL2400 | Square | 24" | 24" | 24" | 44 | 8 | 21" x 21" | 20.5" x 20.5" | CWC-R1850/CWM-R1114-2k |
| WVRT-AL2400 | Square Tall | 24" | 24" | 48" | 51 | 15.1 | 21" x 21" | 23.5" x 23.5" | CWC-R1850 |
| WWR-AL3000 | Square | 30" | 30" | 27" | 61 | 14 | 27" x 27" | 25.5" x 25.5" | CWM-R1620-2k |
| WVRT-AL3000 | Square Tall | 30" | 30" | 54" | 71 | 26.6 | 27" x 27" | 29.5" x 29.5" | CWM-R1620-2k-CRT |
| WWR-AL361012 | Rectangle | 36" | 10" | 12" | 20 | 2.3 | 33" x 7" | 35.5" x 9.5" | CWM-R1109-2k |
| WWR-AL361218 | Rectangle | 36" | 12" | 18" | 35 | 4.3 | 33" x 9" | 35.5" x 11.5" | CWM-R1114-2k |
| WWR-AL361236 | Rectangle | 36" | 12" | 36" | 56 | 8.5 | 33" x 9" | 35.5" x 11.5" | CWM-R1120-2k |
| WWR-AL361818 | Rectangle | 36" | 18" | 18" | 41 | 6.5 | 33" x 15" | 35.5" x 17.5" | CWM-R1114-2k |
| WWR-AL361824 | Rectangle | 36" | 18" | 24" | 49 | 8.6 | 33" x 15" | 35.5" x 17.5" | CWM-R2020-MS |
| WWR-AL361830 | Rectangle | 36" | 18" | 30" | 57 | 10.5 | 33" x 15" | 35.5" x 17.5" | CWM-R2020-MS |

Wilshire Planters Aluminum Rectangle & Square

- 100% recyclable marine-grade aluminum
- Same strength as Wilshire Steel but weigh 40-60% less
- Engineered for strength with welded stiffeners
- Laser-cut & welded for consistent thickness and edge-detail at any scale
- Powder-coat over zinc-free epoxy primer

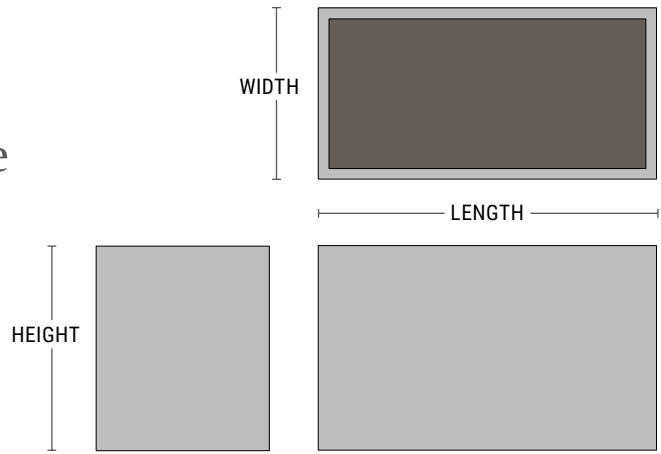

| PRODUCT | SHAPE | LENGTH | WIDTH | HEIGHT | WEIGHT (LBS.) | VOLUME (CUBIC FT.) | INTERIOR TOP | INTERIOR BOTTOM | IRRIGATION |
|--------------|-----------|--------|-------|--------|---------------|--------------------|--------------|-----------------|--------------|
| WWR-AL361836 | Rectangle | 36" | 18" | 36" | 65 | 12.7 | 33" x 15" | 35.5" x 17.5" | CWM-R2020-MS |
| WWR-AL362418 | Rectangle | 36" | 24" | 18" | 47 | 8.7 | 33" x 21" | 35.5" x 23.5" | CWM-R2014-MS |
| WWR-AL362424 | Rectangle | 36" | 24" | 24" | 56 | 11.6 | 33" x 21" | 35.5" x 23.5" | CWM-R2920-MS |
| WWR-AL362430 | Rectangle | 36" | 24" | 30" | 65 | 14.1 | 33" x 21" | 35.5" x 23.5" | CWM-R2920-MS |
| WWR-AL362436 | Rectangle | 36" | 24" | 36" | 73 | 17.4 | 33" x 21" | 35.5" x 23.5" | CWM-R2920-MS |
| WWR-AL362442 | Rectangle | 36" | 24" | 42" | 82 | 19.7 | 33" x 21" | 35.5" x 23.5" | CWM-R2920-MS |
| WWR-AL363018 | Rectangle | 36" | 30" | 18" | 53 | 10.9 | 33" x 27" | 35.5" x 29.5" | CWM-R2914-MS |
| WWR-AL363024 | Rectangle | 36" | 30" | 24" | 62 | 13.7 | 33" x 27" | 35.5" x 29.5" | CWM-R2920-MS |
| WWR-AL363030 | Rectangle | 36" | 30" | 30" | 72 | 17.3 | 33" x 27" | 35.5" x 29.5" | CWM-R2920-MS |
| WWR-AL363036 | Rectangle | 36" | 30" | 36" | 82 | 20.8 | 33" x 27" | 35.5" x 29.5" | CWM-R2920-MS |
| WWR-AL363042 | Rectangle | 36" | 30" | 42" | 92 | 24.4 | 33" x 27" | 35.5" x 29.5" | CWM-R2920-MS |
| WWR-AL363618 | Square | 36" | 36" | 18" | 59 | 12.4 | 31" x 31" | 35.5" x 35.5" | CWM-R1114-2k |
| WWR-AL363624 | Square | 36" | 36" | 24" | 69 | 16.2 | 31" x 31" | 35.5" x 35.5" | CWM-R1120-2k |
| WWR-AL363600 | Square | 36" | 36" | 30" | 80 | 22 | 31" x 31" | 35.5" x 35.5" | CWM-R1620-2k |
| WWR-AL363636 | Square | 36" | 36" | 36" | 90 | 24.6 | 31" x 31" | 35.5" x 35.5" | CWM-R1120-2k |
| WWR-AL363642 | Square | 36" | 36" | 42" | 116 | 28.8 | 31" x 31" | 35.5" x 35.5" | CWM-R1120-2k |
| WWR-AL4200 | Square | 42" | 42" | 36" | 95 | 37 | 37" x 37" | 43.5" x 43.5" | CWM-1720-4K |
| WWR-AL481012 | Rectangle | 48" | 10" | 12" | 25 | 3.1 | 45" x 7" | 47.5" x 9.5" | CWM-R1109-2k |
| WWR-AL481218 | Rectangle | 48" | 12" | 18" | 39 | 5.7 | 45" x 9" | 47.5" x 11.5" | CWM-R1114-2k |
| WWR-AL481236 | Rectangle | 48" | 12" | 36" | 50 | 11.3 | 45" x 9" | 47.5" x 11.5" | CWM-R1120-2k |

Wilshire Planters Aluminum Rectangle & Square

- 100% recyclable marine-grade aluminum
- Same strength as Wilshire Steel but weigh 40-60% less
- Engineered for strength with welded stiffeners
- Laser-cut & welded for consistent thickness and edge-detail at any scale
- Powder-coat over zinc-free epoxy primer

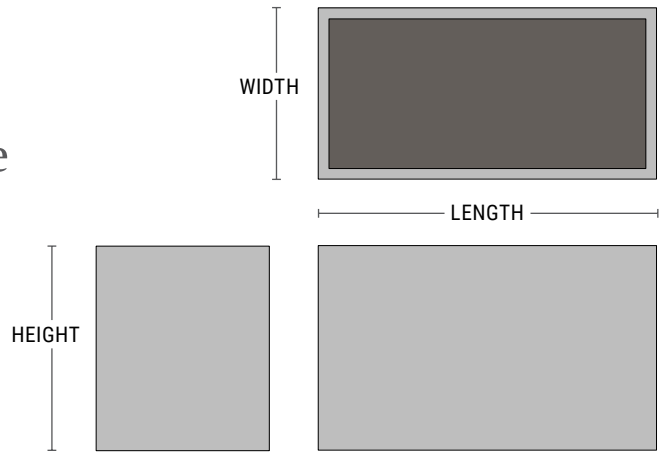

| PRODUCT | SHAPE | LENGTH | WIDTH | HEIGHT | WEIGHT (LBS.) | VOLUME (CUBIC FT.) | INTERIOR TOP | INTERIOR BOTTOM | IRRIGATION |
|--------------|-----------|--------|-------|--------|---------------|--------------------|--------------|-----------------|--------------|
| WWR-AL481818 | Rectangle | 48" | 18" | 18" | 50 | 8.6 | 45" x 15" | 47.5" x 17.5" | CWM-R1114-2k |
| WWR-AL481824 | Rectangle | 48" | 18" | 24" | 60 | 11.5 | 45" x 15" | 47.5" x 17.5" | CWM-R1620-2k |
| WWR-AL481830 | Rectangle | 48" | 18" | 30" | 80 | 13.5 | 45" x 15" | 47.5" x 17.5" | CWM-R1620-2k |
| WWR-AL481836 | Rectangle | 48" | 18" | 36" | 89 | 17 | 45" x 15" | 47.5" x 17.5" | CWM-R1620-2k |
| WWR-AL482418 | Rectangle | 48" | 24" | 18" | 60 | 11.5 | 45" x 21" | 47.5" x 23.5" | CWM-R1614-2k |
| WWR-AL482424 | Rectangle | 48" | 24" | 24" | 67 | 15 | 45" x 21" | 47.5" x 23.5" | CWM-R1620-2k |
| WWR-AL482430 | Rectangle | 48" | 24" | 30" | 78 | 18.8 | 45" x 21" | 47.5" x 23.5" | CWM-R1620-2k |
| WWR-AL482436 | Rectangle | 48" | 24" | 36" | 99 | 23.3 | 45" x 21" | 47.5" x 23.5" | CWM-R1620-2k |
| WWR-AL482442 | Rectangle | 48" | 24" | 42" | 109 | 26.3 | 45" x 21" | 47.5" x 23.5" | CWM-R1620-2k |
| WWR-AL483018 | Rectangle | 48" | 30" | 18" | 64 | 14.5 | 45" x 27" | 47.5" x 29.5" | CWM-R1614-2k |
| WWR-AL483024 | Rectangle | 48" | 30" | 24" | 85 | 18.3 | 45" x 27" | 47.5" x 29.5" | CWM-R1620-2k |
| WWR-AL483030 | Rectangle | 48" | 30" | 30" | 97 | 23 | 45" x 27" | 47.5" x 29.5" | CWM-R1620-2k |
| WWR-AL483036 | Rectangle | 48" | 30" | 36" | 108 | 27.8 | 45" x 27" | 47.5" x 29.5" | CWM-R1620-2k |
| WWR-AL483042 | Rectangle | 48" | 30" | 42" | 125 | 32.5 | 45" x 27" | 47.5" x 29.5" | CWM-R1620-2k |
| WWR-AL483618 | Rectangle | 48" | 36" | 18" | 70 | 16.6 | 43" x 31" | 47.5" x 35.5" | CWM-R1614-2k |
| WWR-AL483624 | Rectangle | 48" | 36" | 24" | 93 | 21.7 | 43" x 31" | 47.5" x 35.5" | CWM-R1620-2k |
| WWR-AL483630 | Rectangle | 48" | 36" | 30" | 105 | 27.4 | 43" x 31" | 47.5" x 35.5" | CWM-R1620-2k |
| WWR-AL483636 | Rectangle | 48" | 36" | 36" | 123 | 33 | 43" x 31" | 47.5" x 35.5" | CWM-R1620-2k |
| WWR-AL483642 | Rectangle | 48" | 36" | 42" | 137 | 38.6 | 43" x 31" | 47.5" x 35.5" | CWM-R1620-2k |
| WWR-AL484818 | Rectangle | 48" | 48" | 18" | 84 | 22.1 | 43" x 43" | 47.5" x 47.5" | CWM-R1614-2k |

Wilshire Planters Aluminum Rectangle & Square

- 100% recyclable marine-grade aluminum
- Same strength as Wilshire Steel but weigh 40-60% less
- Engineered for strength with welded stiffeners
- Laser-cut & welded for consistent thickness and edge-detail at any scale
- Powder-coat over zinc-free epoxy primer

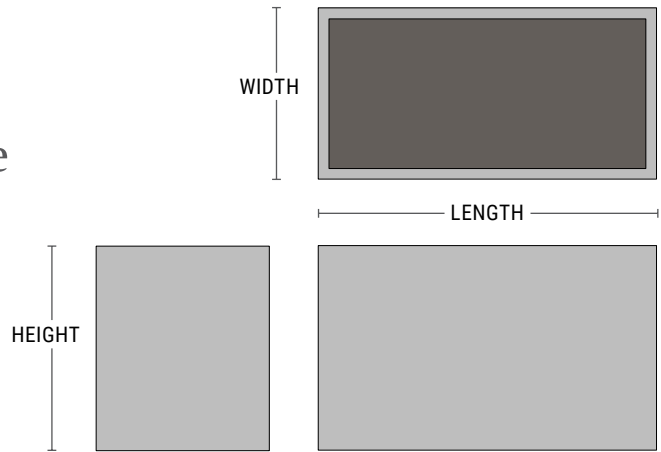

| PRODUCT | SHAPE | LENGTH | WIDTH | HEIGHT | WEIGHT (LBS.) | VOLUME (CUBIC FT.) | INTERIOR TOP | INTERIOR BOTTOM | IRRIGATION |
|--------------|-----------|--------|-------|--------|---------------|--------------------|--------------|-----------------|--------------|
| WWR-AL4824 | Square | 48" | 48" | 24" | 98 | 29 | 43" x 43" | 43.5" x 43.5" | CWM-R2914-2k |
| WWR-AL484830 | Square | 48" | 48" | 30" | 132 | 36.3 | 43" x 43" | 47.5" x 47.5" | CWM-R1620-2k |
| WWR-AL4800 | Square | 48" | 48" | 36" | 146 | 48 | 43" x 43" | 43.5" x 43.5" | CWM-R2920-2k |
| WWR-AL484842 | Square | 48" | 48" | 42" | 161 | 51.1 | 43" x 43" | 47.5" x 47.5" | CWM-R1620-2k |
| WWR-AL601012 | Rectangle | 60" | 10" | 12" | 39 | 3.9 | 57" x 7" | 59.5" x 9.5" | CWM-R1109-2k |
| WWR-AL601218 | Rectangle | 60" | 12" | 18" | 52 | 7.1 | 57" x 9" | 59.5" x 11.5" | CWM-R1114-2k |
| WWR-AL601236 | Rectangle | 60" | 12" | 36" | 96 | 14.2 | 57" x 9" | 59.5" x 11.5" | CWM-R1120-2k |
| WWR-AL601818 | Rectangle | 60" | 18" | 18" | 59 | 10.8 | 57" x 15" | 59.5" x 17.5" | CWM-R1114-2k |
| WWR-AL601824 | Rectangle | 60" | 18" | 24" | 74 | 14.4 | 57" x 15" | 59.5" x 17.5" | CWM-R1620-2k |
| WWR-AL601830 | Rectangle | 60" | 18" | 30" | 95 | 16.9 | 57" x 15" | 59.5" x 17.5" | CWM-R2020-2k |
| WWR-AL601836 | Rectangle | 60" | 18" | 36" | 106 | 21.2 | 57" x 15" | 59.5" x 17.5" | CWM-R2020-2k |
| WWR-AL602418 | Rectangle | 60" | 24" | 18" | 67 | 14.5 | 57" x 21" | 59.5" x 23.5" | CWM-R2014-2k |
| WWR-AL602424 | Rectangle | 60" | 24" | 24" | 92 | 18.8 | 57" x 21" | 59.5" x 23.5" | CWM-R2020-2k |
| WWR-AL602430 | Rectangle | 60" | 24" | 30" | 104 | 23.5 | 57" x 21" | 59.5" x 23.5" | CWM-R2020-2k |
| WWR-AL602436 | Rectangle | 60" | 24" | 36" | 122 | 29.1 | 57" x 21" | 59.5" x 23.5" | CWM-R2020-2k |
| WWR-AL602442 | Rectangle | 60" | 24" | 42" | 135 | 32.9 | 57" x 21" | 59.5" x 23.5" | CWM-R2020-2k |
| WWR-AL603018 | Rectangle | 60" | 30" | 18" | 74 | 18.2 | 57" x 27" | 59.5" x 29.5" | CWM-R2014-2k |
| WWR-AL603024 | Rectangle | 60" | 30" | 24" | 100 | 22.8 | 57" x 27" | 59.5" x 29.5" | CWM-R2020-2k |
| WWR-AL603030 | Rectangle | 60" | 30" | 30" | 118 | 28.8 | 57" x 27" | 59.5" x 29.5" | CWM-R2020-2k |
| WWR-AL603036 | Rectangle | 60" | 30" | 36" | 132 | 34.7 | 57" x 27" | 59.5" x 29.5" | CWM-R2020-2k |

Wilshire Planters Aluminum Rectangle & Square

- 100% recyclable marine-grade aluminum
- Same strength as Wilshire Steel but weigh 40-60% less
- Engineered for strength with welded stiffeners
- Laser-cut & welded for consistent thickness and edge-detail at any scale
- Powder-coat over zinc-free epoxy primer

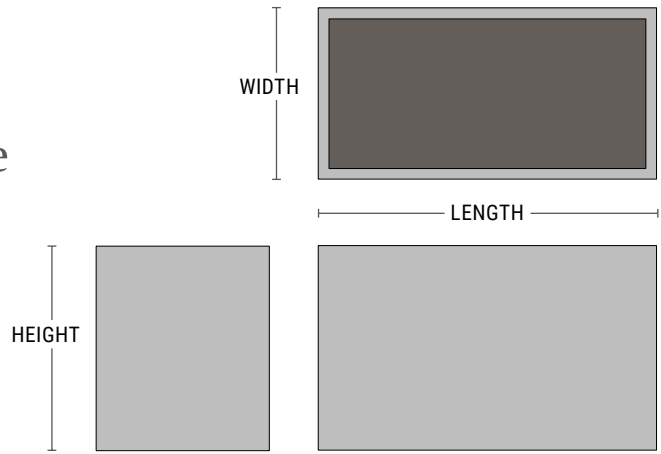

| PRODUCT | SHAPE | LENGTH | WIDTH | HEIGHT | WEIGHT (LBS.) | VOLUME (CUBIC FT.) | INTERIOR TOP | INTERIOR BOTTOM | IRRIGATION |
|--------------|-----------|--------|-------|--------|---------------|--------------------|--------------|-----------------|--------------|
| WWR-AL603042 | Rectangle | 60" | 30" | 42" | 146 | 40.7 | 57" x 27" | 59.5" x 29.5" | CWM-R2020-2k |
| WWR-AL603618 | Rectangle | 60" | 36" | 18" | 82 | 20.7 | 55" x 31" | 59.5" x 35.5" | CWM-R2014-2k |
| WWR-AL603624 | Rectangle | 60" | 36" | 24" | 109 | 27.3 | 55" x 31" | 59.5" x 35.5" | CWM-R2020-2k |
| WWR-AL603630 | Rectangle | 60" | 36" | 30" | 123 | 34.4 | 55" x 31" | 59.5" x 35.5" | CWM-R2020-2k |
| WWR-AL603636 | Rectangle | 60" | 36" | 36" | 142 | 41.4 | 55" x 31" | 59.5" x 35.5" | CWM-R2020-2k |
| WWR-AL603642 | Rectangle | 60" | 36" | 42" | 157 | 48.5 | 55" x 31" | 59.5" x 35.5" | CWM-R2020-2k |
| WWR-AL604818 | Rectangle | 60" | 48" | 18" | 102 | 27.7 | 55" x 43" | 59.5" x 47.5" | CWM-R2014-2k |
| WWR-AL604824 | Rectangle | 60" | 48" | 24" | 129 | 36.3 | 55" x 43" | 59.5" x 47.5" | CWM-R2014-2k |
| WWR-AL604830 | Rectangle | 60" | 48" | 30" | 152 | 45.7 | 55" x 43" | 59.5" x 47.5" | CWM-R2020-2k |
| WWR-AL604836 | Rectangle | 60" | 48" | 36" | 173 | 54.9 | 55" x 43" | 59.5" x 47.5" | CWM-R2020-2k |
| WWR-AL604842 | Rectangle | 60" | 48" | 42" | 190 | 64.3 | 55" x 43" | 59.5" x 47.5" | CWM-R2020-2k |
| WWR-AL6000 | Square | 60" | 60" | 42" | 234 | 80 | 55" x 55" | 55.5" x 55.5" | CWM-R2920-4k |
| WWR-AL721012 | Rectangle | 72" | 10" | 12" | 45 | 4.7 | 69" x 7" | 71.5" x 9.5" | CWM-R1109-3k |
| WWR-AL721218 | Rectangle | 72" | 12" | 18" | 62 | 8.5 | 69" x 9" | 71.5" x 11.5" | CWM-R1114-3k |
| WWR-AL721236 | Rectangle | 72" | 12" | 36" | 112 | 17 | 69" x 9" | 71.5" x 11.5" | CWM-R1120-3k |
| WWR-AL721818 | Rectangle | 72" | 18" | 18" | 68 | 12.9 | 69" x 15" | 71.5" x 17.5" | CWM-R1114-3k |
| WWR-AL721824 | Rectangle | 72" | 18" | 24" | 97 | 17.3 | 69" x 15" | 71.5" x 17.5" | CWM-R1620-3k |
| WWR-AL721830 | Rectangle | 72" | 18" | 30" | 114 | 20.2 | 69" x 15" | 71.5" x 17.5" | CWM-R1620-3k |
| WWR-AL721836 | Rectangle | 72" | 18" | 36" | 123 | 25.5 | 69" x 15" | 71.5" x 17.5" | CWM-R1620-3k |
| WWR-AL722418 | Rectangle | 72" | 24" | 18" | 79 | 17.4 | 69" x 21" | 71.5" x 23.5" | CWM-R1614-3k |

Wilshire Planters Aluminum Rectangle & Square

- 100% recyclable marine-grade aluminum
- Same strength as Wilshire Steel but weigh 40-60% less
- Engineered for strength with welded stiffeners
- Laser-cut & welded for consistent thickness and edge-detail at any scale
- Powder-coat over zinc-free epoxy primer

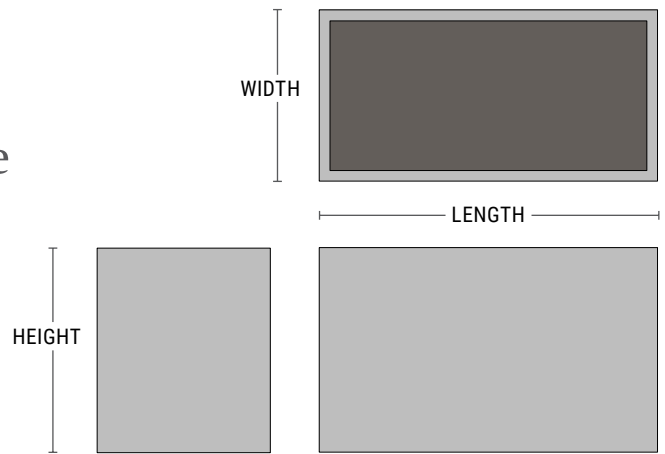

| PRODUCT | SHAPE | LENGTH | WIDTH | HEIGHT | WEIGHT (LBS.) | VOLUME (CUBIC FT.) | INTERIOR TOP | INTERIOR BOTTOM | IRRIGATION |
|--------------|-----------|--------|-------|--------|---------------|--------------------|--------------|-----------------|----------------|
| WWR-AL722424 | Rectangle | 72" | 24" | 24" | 94 | 22.6 | 69" x 21" | 71.5" x 23.5" | CWM-R1620-3k |
| WWR-AL722430 | Rectangle | 72" | 24" | 30" | 125 | 28.2 | 69" x 21" | 71.5" x 23.5" | CWM-R1620-3k |
| WWR-AL722436 | Rectangle | 72" | 24" | 36" | 140 | 35 | 69" x 21" | 71.5" x 23.5" | CWM-R1620-3k |
| WWR-AL722442 | Rectangle | 72" | 24" | 42" | 155 | 39.5 | 69" x 21" | 71.5" x 23.5" | CWM-R1620-3k |
| WWR-AL723018 | Rectangle | 72" | 30" | 18" | 88 | 21.8 | 69" x 27" | 71.5" x 29.5" | CWM-R1614-3k |
| WWR-AL723024 | Rectangle | 72" | 30" | 24" | 119 | 27.4 | 69" x 27" | 71.5" x 29.5" | CWM-R1620-3k |
| WWR-AL723030 | Rectangle | 72" | 30" | 30" | 135 | 34.5 | 69" x 27" | 71.5" x 29.5" | CWM-R1620-3k |
| WWR-AL723036 | Rectangle | 72" | 30" | 36" | 146 | 41.7 | 69" x 27" | 71.5" x 29.5" | CWM-R1620-3k |
| WWR-AL723042 | Rectangle | 72" | 30" | 42" | 167 | 48.8 | 69" x 27" | 71.5" x 29.5" | CWM-R1620-3k |
| WWR-AL723618 | Rectangle | 72" | 36" | 18" | 96 | 24.9 | 67" x 31" | 71.5" x 35.5" | CWM-R1614-3k |
| WWR-AL723624 | Rectangle | 72" | 36" | 24" | 125 | 32.8 | 67" x 31" | 71.5" x 35.5" | CWM-R1620-3k |
| WWR-AL723630 | Rectangle | 72" | 36" | 30" | 141 | 41.3 | 67" x 31" | 71.5" x 35.5" | CWM-R1620-3k |
| WWR-AL723636 | Rectangle | 72" | 36" | 36" | 162 | 49.8 | 67" x 31" | 71.5" x 35.5" | CWM-R1620-3k |
| WWR-AL723642 | Rectangle | 72" | 36" | 42" | 179 | 58.3 | 67" x 31" | 71.5" x 35.5" | CWM-R1620-3k |
| WWR-AL724818 | Rectangle | 72" | 48" | 18" | 113 | 33.3 | 67" x 43" | 71.5" x 47.5" | CWM-R1614-3k |
| WWR-AL724824 | Rectangle | 72" | 48" | 24" | 129 | 43.6 | 67" x 43" | 71.5" x 47.5" | CWM-R1614-3k |
| WWR-AL724830 | Rectangle | 72" | 48" | 30" | 172 | 55 | 67" x 43" | 71.5" x 47.5" | CWM-R1620-3k |
| WWR-AL724836 | Rectangle | 72" | 48" | 36" | 194 | 66.1 | 67" x 43" | 71.5" x 47.5" | CWM-R1620-3k |
| WWR-AL724842 | Rectangle | 72" | 48" | 42" | 228 | 77.4 | 67" x 43" | 71.5" x 47.5" | CWM-R1620-3k |
| WWR-AL7200 | Square | 72" | 72" | 42" | 297 | 120 | 67" x 67" | 67.5" x 67.5" | CWM-R2020-4k-E |

Wilshire Planters Aluminum Rectangle & Square

- 100% recyclable marine-grade aluminum
- Same strength as Wilshire Steel but weigh 40-60% less
- Engineered for strength with welded stiffeners
- Laser-cut & welded for consistent thickness and edge-detail at any scale
- Powder-coat over zinc-free epoxy primer

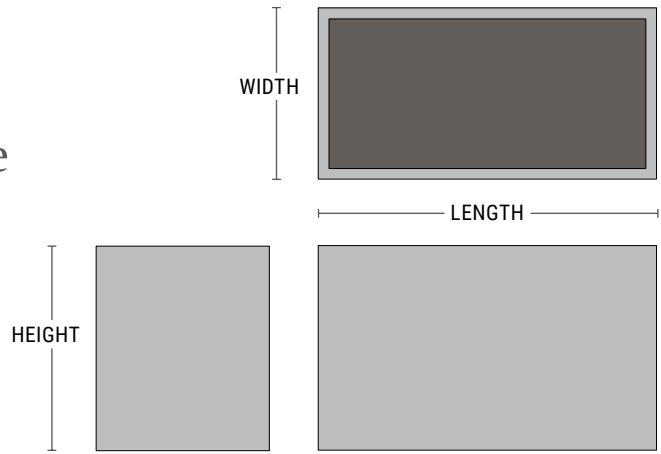

| PRODUCT | SHAPE | LENGTH | WIDTH | HEIGHT | WEIGHT (LBS.) | VOLUME (CUBIC FT.) | INTERIOR TOP | INTERIOR BOTTOM | IRRIGATION |
|--------------|-----------|--------|-------|--------|---------------|--------------------|--------------|-----------------|--------------|
| WWR-AL961012 | Rectangle | 96" | 10" | 12" | 59 | 6.3 | 93" x 7" | 95.5" x 9.5" | CWM-R1109-5k |
| WWR-AL961218 | Rectangle | 96" | 12" | 18" | 79 | 11.4 | 93" x 9" | 95.5" x 11.5" | CWM-R1114-4k |
| WWR-AL961236 | Rectangle | 96" | 12" | 36" | 145 | 22.6 | 93" x 9" | 95.5" x 11.5" | CWM-R1120-4k |
| WWR-AL961818 | Rectangle | 96" | 18" | 18" | 89 | 17.3 | 93" x 15" | 95.5" x 17.5" | CWM-R1114-4k |
| WWR-AL961824 | Rectangle | 96" | 18" | 24" | 127 | 23.1 | 93" x 15" | 95.5" x 17.5" | CWM-R1620-4k |
| WWR-AL961830 | Rectangle | 96" | 18" | 30" | 145 | 27 | 93" x 15" | 95.5" x 17.5" | CWM-R1620-4k |
| WWR-AL961836 | Rectangle | 96" | 18" | 36" | 157 | 34 | 93" x 15" | 95.5" x 17.5" | CWM-R1620-4k |
| WWR-AL962418 | Rectangle | 96" | 24" | 18" | 99 | 23.2 | 93" x 21" | 95.5" x 23.5" | CWM-R1614-4k |
| WWR-AL962424 | Rectangle | 96" | 24" | 24" | 138 | 30.1 | 93" x 21" | 95.5" x 23.5" | CWM-R1620-4k |
| WWR-AL962430 | Rectangle | 96" | 24" | 30" | 157 | 37.7 | 93" x 21" | 95.5" x 23.5" | CWM-R1620-4k |
| WWR-AL962436 | Rectangle | 96" | 24" | 36" | 175 | 46.7 | 93" x 21" | 95.5" x 23.5" | CWM-R1620-4k |
| WWR-AL962442 | Rectangle | 96" | 24" | 42" | 215 | 52.7 | 93" x 21" | 95.5" x 23.5" | CWM-R1620-4k |
| WWR-AL963018 | Rectangle | 96" | 30" | 18" | 109 | 27.6 | 93" x 27" | 95.5" x 29.5" | CWM-R1614-4k |
| WWR-AL963024 | Rectangle | 96" | 30" | 24" | 129 | 36.6 | 93" x 27" | 95.5" x 29.5" | CWM-R1620-4k |
| WWR-AL963030 | Rectangle | 96" | 30" | 30" | 169 | 46.1 | 93" x 27" | 95.5" x 29.5" | CWM-R1620-4k |
| WWR-AL963036 | Rectangle | 96" | 30" | 36" | 188 | 55.6 | 93" x 27" | 95.5" x 29.5" | CWM-R1620-4k |
| WWR-AL963042 | Rectangle | 96" | 30" | 42" | 235 | 65.1 | 93" x 27" | 95.5" x 29.5" | CWM-R1620-4k |
| WWR-AL963618 | Rectangle | 96" | 36" | 18" | 120 | 33.2 | 91" x 31" | 95.5" x 35.5" | CWM-R1614-4k |
| WWR-AL963624 | Rectangle | 96" | 36" | 24" | 140 | 43.9 | 91" x 31" | 95.5" x 35.5" | CWM-R1620-4k |
| WWR-AL963630 | Rectangle | 96" | 36" | 30" | 181 | 55.3 | 91" x 31" | 95.5" x 35.5" | CWM-R1620-4k |

Wilshire Planters Aluminum Rectangle & Square

- 100% recyclable marine-grade aluminum
- Same strength as Wilshire Steel but weigh 40-60% less
- Engineered for strength with welded stiffeners
- Laser-cut & welded for consistent thickness and edge-detail at any scale
- Powder-coat over zinc-free epoxy primer

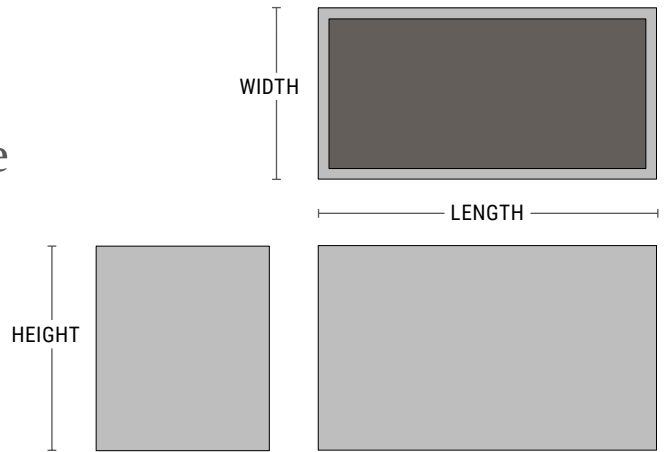

| PRODUCT | SHAPE | LENGTH | WIDTH | HEIGHT | WEIGHT (LBS.) | VOLUME (CUBIC FT.) | INTERIOR TOP | INTERIOR BOTTOM | IRRIGATION |
|--------------|-----------|--------|-------|--------|---------------|--------------------|--------------|-----------------|--------------|
| WWR-AL963636 | Rectangle | 96" | 36" | 36" | 229 | 66.6 | 91" x 31" | 95.5" x 35.5" | CWM-R1620-4k |
| WWR-AL963642 | Rectangle | 96" | 36" | 42" | 250 | 78 | 91" x 31" | 95.5" x 35.5" | CWM-R1620-4k |
| WWR-AL964818 | Rectangle | 96" | 48" | 18" | 140 | 44.4 | 91" x 43" | 95.5" x 47.5" | CWM-R1614-4k |
| WWR-AL964824 | Rectangle | 96" | 48" | 24" | 190 | 58.4 | 91" x 43" | 95.5" x 47.5" | CWM-R1614-4k |
| WWR-AL964830 | Rectangle | 96" | 48" | 30" | 215 | 73.6 | 91" x 43" | 95.5" x 47.5" | CWM-R1620-4k |
| WWR-AL964836 | Rectangle | 96" | 48" | 36" | 258 | 88.5 | 91" x 43" | 95.5" x 47.5" | CWM-R1620-4k |
| WWR-AL964842 | Rectangle | 96" | 48" | 42" | 296 | 103.7 | 91" x 43" | 95.5" x 47.5" | CWM-R1620-4k |



Wilshire Planters Aluminum Round

Wilshire Powder-Coated Aluminum Planters are an environmentally friendly option. Marine-grade aluminum is used to produce planters with the strength of steel but 40-60% of the weight.

Wilshire Planters, Aluminum Round

WILSHIRE PLANTERS, ALUMINUM ROUND

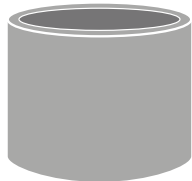

Round

THE COMPLETE WILSHIRE COLLECTION

For additional shapes and materials, visit tournesol.com/collections/wilshire

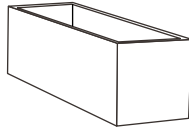

Rectangle

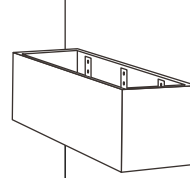

Hanging Box

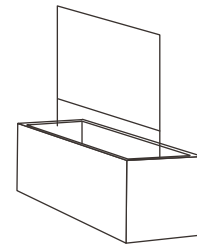

Trellis, Laser-Cut Screen

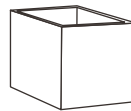

Square

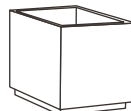

Toe Kick

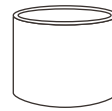

Round



Round with Toe Kick

OPTIONS

Standard Wilshire Planters can be modified with a broad array of options without incurring custom charges. Options are limited to those products that can support them. Speak to a Tournesol Advisor to discuss which options will work with your project.



Irrigation



Change Dimension



Casters



Drain Holes



False Bottom



Toe Kick



Tie Downs



Custom Color

Wilshire Planters, Aluminum Round

POWDER-COATED ALUMINUM

Following fabrication, Wilshire Aluminum Planters are dry steam washed and pretreated with a closed loop, environmentally friendly zirconium solution before a zinc-free epoxy primer and AAMA 2604 polyester powder-coat is applied.

TOP LIP

Wilshire Planters in Aluminum come with a standard lip return.

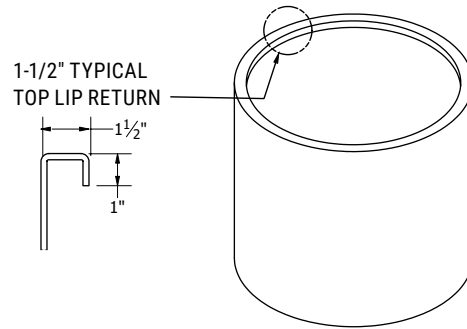

BASE OPTION

See Wilshire Aluminum Round with Toe-kick Planters, if toe kick is desired.

DRAINAGE

Drain Holes: Standard drain holes are 1-5/8" diameter, made free-of-charge at the factory.

Wilshire Planters, Aluminum Round

- 100% recyclable marine-grade aluminum
- Same strength as Wilshire Steel but weigh 40-60% less
- Engineered for strength with welded stiffeners
- Laser-cut & welded for consistent thickness and edge-detail at any scale
- Powder-coat over zinc-free epoxy primer

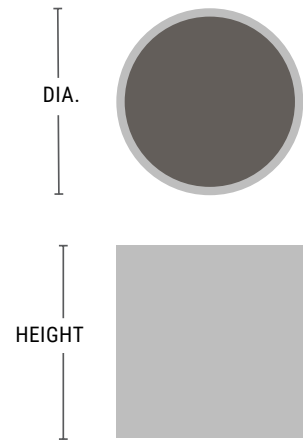

| PRODUCT | SHAPE | DIA. | HEIGHT | WEIGHT (LBS.) | VOLUME (CUBIC FT.) | INTERIOR TOP | INTERIOR BOTTOM | IRRIGATION |
|-------------|-------|---------|--------|---------------|--------------------|--------------|-----------------|----------------------|
| WWS-AL1800F | Round | 18" dia | 20" | 18 | 3 | 15" dia | 14.5" dia | CWC-1216 |
| WWS-AL2400F | Round | 24" dia | 24" | 29 | 6 | 21" dia | 20.5" dia | CWC-1600/CWM-1114-2k |
| WWS-AL3000F | Round | 30" dia | 27" | 42 | 11 | 27" dia | 25.5" dia | CWC-2400/CWM-1720-2k |
| WWS-AL3600F | Round | 36" dia | 30" | 56 | 17 | 33" dia | 31.5" dia | CWM-1720-3k |
| WWS-AL4200F | Round | 42" dia | 33" | 125 | 26 | 39" dia | 37.5" dia | CWM-1720-3k |
| WWS-AL4800F | Round | 48" dia | 36" | 157 | 37 | 45" dia | 43.5" dia | CWM-2920-3k |
| WWS-AL6000F | Round | 60" dia | 36" | 202 | 57 | 57" dia | 55.5" dia | CWM-2920-4k |
| WWS-AL7200F | Round | 72" dia | 42" | 285 | 96 | 69" dia | 67.5" dia | CWM-2920-5k |



Wilshire Planters Aluminum Round with Toe Kick

Wilshire Powder-Coated Aluminum Planters are an environmentally friendly option. Marine-grade aluminum is used to produce planters with the strength of steel but 40-60% of the weight.

Wilshire Planters, Aluminum Round with Toe Kick

WILSHIRE PLANTERS,
ALUMINUM ROUND
WITH TOE KICK

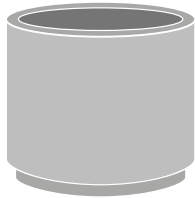

Round with Toe Kick

THE COMPLETE WILSHIRE COLLECTION
For additional shapes and materials, visit
tournesol.com/collections/wilshire

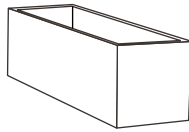

Rectangle

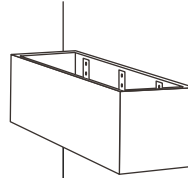

Hanging Box

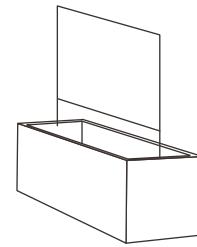

Trellis, Laser-Cut Screen

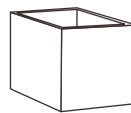

Square

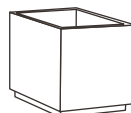

Toe Kick

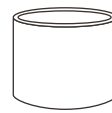

Round



Round with Toe Kick

OPTIONS

Standard Wilshire Planters can be modified with a broad array of options without incurring custom charges. Options are limited to those products that can support them. Speak to a Tournesol Advisor to discuss which options will work with your project.



Irrigation



Change Dimension



Casters



Drain Holes



False Bottom



Tie Downs



Custom Color

Wilshire Planters, Aluminum Round with Toe Kick

POWDER-COATED ALUMINUM

Following fabrication, Wilshire Aluminum Planters are dry steam washed and pretreated with a closed loop, environmentally friendly zirconium solution before a zinc-free epoxy primer and AAMA 2604 polyester powder-coat is applied.

TOP LIP

Wilshire Planters in Aluminum come with a standard lip return.

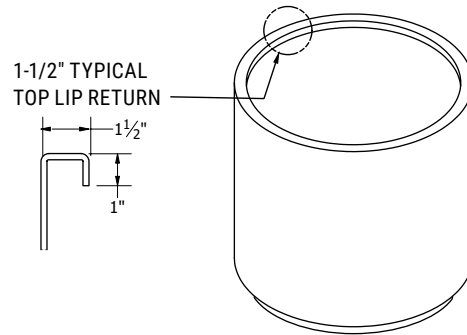

BASE OPTION

See Wilshire Aluminum Round if no Toe Kick is desired. Wilshire Aluminum Planters are available with a toe kick option.

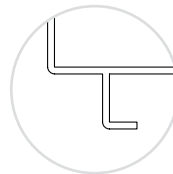

WWR-RE

Toe kick option
2"H bottom reveal

DRAINAGE

Drain Holes: Standard drain holes are 1-5/8" diameter, made free-of-charge at the factory.

Wilshire Planters Aluminum Round with Toe Kick

- 100% recyclable marine-grade aluminum
- Same strength as Wilshire Steel but weigh 40-60% less
- Engineered for strength with welded stiffeners
- Laser-cut & welded for consistent thickness and edge-detail at any scale
- Powder-coat over zinc-free epoxy primer

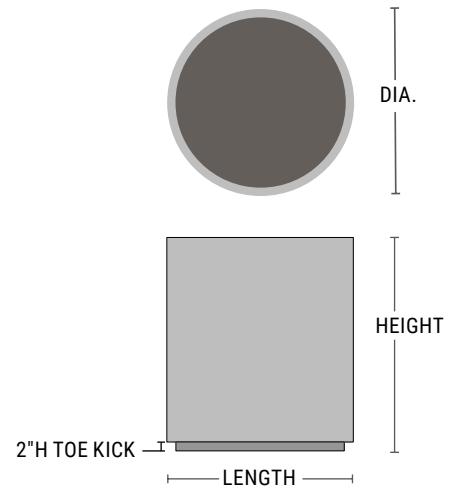

| PRODUCT | SHAPE | DIA. | HEIGHT | WEIGHT (LBS.) | VOLUME (CUBIC FT.) | INTERIOR TOP | INTERIOR BOTTOM | IRRIGATION |
|-------------|----------------------|---------|--------|---------------|--------------------|--------------|-----------------|----------------------|
| WWS-AL1800 | Toe Kick Round | 18" dia | 20" | 18 | 3 | 15" dia | 14" dia | CWC-1216 |
| WWST-AL1800 | Toe Kick Round, Tall | 18" dia | 30" | 25 | 4 | 15" dia | 14" dia | CWI-1200 |
| WWS-AL2400 | Toe Kick Round | 24" dia | 24" | 29 | 6 | 21" dia | 20" dia | CWC-1600/CWM-1114-2k |
| WWST-AL2400 | Toe Kick Round, Tall | 24" dia | 48" | 51 | 12 | 21" dia | 20" dia | CWI-1700 |
| WWS-AL3000 | Toe Kick Round | 30" dia | 27" | 42 | 11 | 27" dia | 26" dia | CWC-2400/CWM-1720-2k |
| WWST-AL3000 | Toe Kick Round, Tall | 30" dia | 54" | 72 | 21 | 27" dia | 26" dia | CWI-2200 |
| WWS-AL3600 | Toe Kick Round | 36" dia | 30" | 56 | 17 | 33" dia | 32" dia | CWM-1720-3k |
| WWS-AL4200 | Toe Kick Round | 42" dia | 33" | 122 | 25 | 33" dia | 32" dia | CWM-1720-3k |
| WWS-AL4800 | Toe Kick Round | 48" dia | 36" | 153 | 36 | 45" dia | 44" dia | CWM-2920-3k |
| WWS-AL6000 | Toe Kick Round | 60" dia | 36" | 198 | 56 | 57" dia | 56" dia | CWM-2920-4k |
| WWS-AL7200 | Toe Kick Round | 72" dia | 42" | 279 | 94 | 69" dia | 68" dia | CWM-2920-5k |



Wilshire Planters Weathering Steel Rectangle & Square

Weathering Steel planters offer a warm industrial aesthetic favored by many landscape architects. The natural red-orange oxidization forms a protective patina that develops and regenerates continuously. Our A588 and A606 grade steel planters are meticulously assembled and welded.

Weathering Steel or Pre-Weathered Steel

Our Weathering Steel ships with a natural mill scale finish. The initial oxidation develops within weeks and evolves over time. Pre-Weathered Steel products undergo an earth-friendly pre-treatment, which steps up the oxidation process timeline to help achieve the desired visual result faster.

Wilshire Planters, Weathering Steel, Rectangle & Square

WILSHIRE PLANTERS, WEATHERING STEEL RECTANGLES & SQUARES

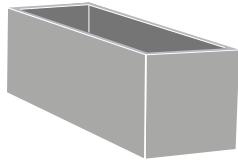

Rectangle

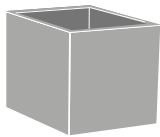

Square

THE COMPLETE WILSHIRE COLLECTION

For additional shapes and materials, visit tournesol.com/collections/wilshire

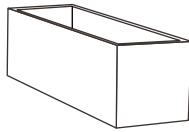

Rectangle

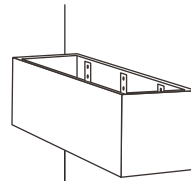

Hanging Box

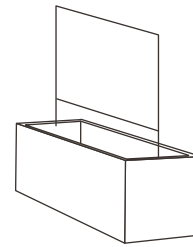

Trellis, Laser-Cut Screen

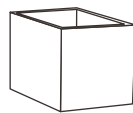

Square

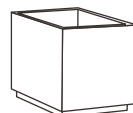

Toe Kick

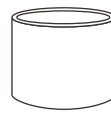

Round



Round with Toe Kick

OPTIONS

Standard Wilshire Planters can be modified with a broad array of options without incurring custom charges. Options are limited to those products that can support them. Speak to a Tournesol Advisor to discuss which options will work with your project.



Irrigation



Change Dimension



Accessory Pockets



Scoops



Casters



Drain Holes



Toe Kick



Tie Downs



Pre-Weathering Treatment

Wilshire Planters, Weathering Steel, Rectangle & Square

Weathering Steel

Our Weathering Steel ships with a natural mill scale finish. The initial oxidation develops within weeks and evolves over time. Environmental conditions such as humidity, salt, and the temperature at installation can affect rust uniformity and formation rate. The color develops from a vibrant orange to a deep reddish-brown.

Pre-Weathered Steel

Our Pre-Weathered Steel products undergo an earth-friendly pre-treatment, which steps up the oxidation process timeline to help achieve the desired visual result faster.

Our process begins by grit-blasting the raw mill scale surface; next we treat it with an all-natural solution of hydrogen peroxide, vinegar, and salt. Treated products cure for a day before being individually wrapped in paper and then plastic before shipping.

Raw mill scale steel and treated surfaces can be powdery and may show markings during delivery and installation. These changes are affected by humidity levels and storage.

Weathering Steel products should be unwrapped upon arrival and stored indoors if possible. Shedding during unpacking and storing may occur; protect flooring during storage and installation.

TOP LIP

Wilshire Planters in Weathering Steel come with a standard lip return.

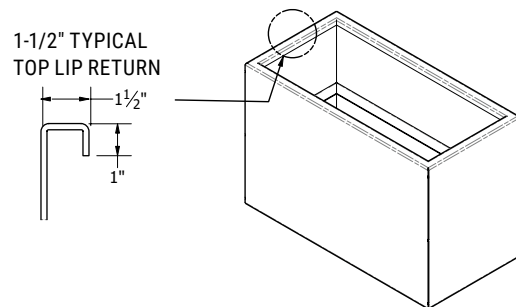

BASE OPTION

Wilshire Planters are available with a toe kick option.

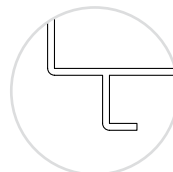

WWR-RE

Toe kick option
2"H bottom reveal

DRAINAGE

Drain Holes: Standard drain holes are 1-5/8" diameter, made free-of-charge at the factory.

Wilshire Planters Weathering Steel, Rectangle & Square

- 12-gauge A588 and A606 Steel
- Engineered to resist deformation
- Fully welded corners
- Optional toe kick available
- Drain holes standard

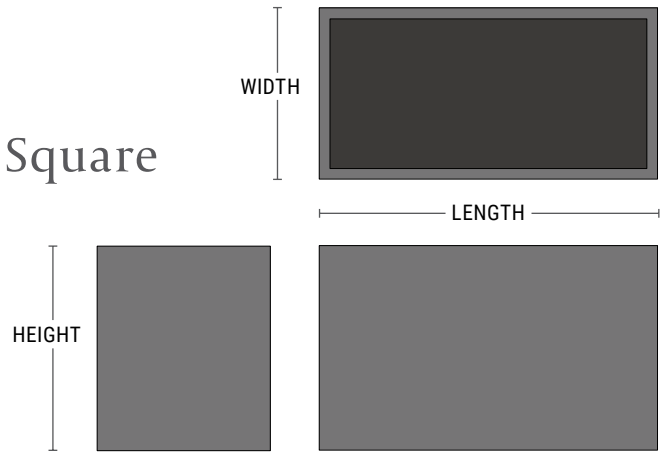

| PRODUCT | SHAPE | LENGTH | WIDTH | HEIGHT | WEIGHT (LBS.) | VOLUME (CUBIC FT.) | INTERIOR TOP | IRRIGATION |
|--------------|---------------|--------|-------|--------|---------------|--------------------|--------------|--------------------------|
| WWR-WS1800 | Square | 18" | 18" | 20" | 64 lbs. | 3.5 | 15" x 15" | - |
| WVRT-WS1800 | Square - tall | 18" | 18" | 30" | 85 lbs. | 5.25 | 15" x 15" | CWM-R2020-MS |
| WWR-WS241012 | Rectangle | 24" | 10" | 12" | 36 lbs. | 1.47 | 21" x 7" | CWM-R1109-MS |
| WWR-WS241218 | Rectangle | 24" | 12" | 18" | 52 lbs. | 2.74 | 21" x 9" | CWM-R1614-MS |
| WWR-WS241818 | Rectangle | 24" | 18" | 18" | 64 lbs. | 4.14 | 21" x 15" | CWM-R2014-MS |
| WWR-WS241824 | Rectangle | 24" | 18" | 24" | 86 lbs. | 5.5 | 21" x 15" | CWM-R2014-MS |
| WWR-WS241830 | Rectangle | 24" | 18" | 30" | 94 lbs. | 7.08 | 21" x 15" | CWM-R2020-MS |
| WWR-WS242418 | Square | 24" | 24" | 18" | 76 lbs. | 5.53 | 21" x 21" | CWM-R2014-MS |
| WWR-WS2400 | Square | 24" | 24" | 24" | 106 lbs. | 7.5 | 21" x 21" | CWC-R1850/CWM-R1114-2k |
| WVRT-WS2400 | Square - tall | 24" | 24" | 48" | 170 lbs. | 15.25 | 21" x 21" | CWC-R1850/CWM-R1120-2k |
| WWR-WS3000 | Square | 30" | 30" | 27" | 150 lbs. | 13 | 27" x 27" | CWM-R1620-3K/CWM-1720-4K |
| WWR-WS361012 | Rectangle | 36" | 10" | 12" | 51 lbs. | 2.21 | 33" x 7" | CWM-R1109-2K |
| WWR-WS361218 | Rectangle | 36" | 12" | 18" | 71 lbs. | 4.13 | 33" x 9" | CWM-R1614-MS |
| WWR-WS361818 | Rectangle | 36" | 18" | 18" | 85 lbs. | 6.23 | 33" x 15" | CWM-R2014-MS |
| WWR-WS361824 | Rectangle | 36" | 18" | 24" | 115 lbs. | 8 | 33" x 15" | CWM-R2014-MS |
| WWR-WS361830 | Rectangle | 36" | 18" | 30" | 134 lbs. | 10.65 | 33" x 15" | CWM-R2020-MS |
| WWR-WS362418 | Rectangle | 36" | 24" | 18" | 99 lbs. | 8.32 | 33" x 21" | CWM-R2014-MS |
| WWR-WS362424 | Rectangle | 36" | 24" | 24" | 132 lbs. | 11 | 33" x 21" | CWM-R2914-MS |
| WWR-WS362430 | Rectangle | 36" | 24" | 30" | 153 lbs. | 14.24 | 33" x 21" | CWM-R2920-MS |
| WWR-WS362436 | Rectangle | 36" | 24" | 36" | 175 lbs. | 17.19 | 33" x 21" | CWM-R2920-MS |

Wilshire Planters Weathering Steel, Rectangle & Square

- 12-gauge A588 and A606 Steel
- Engineered to resist deformation
- Fully welded corners
- Optional toe kick available
- Drain holes standard

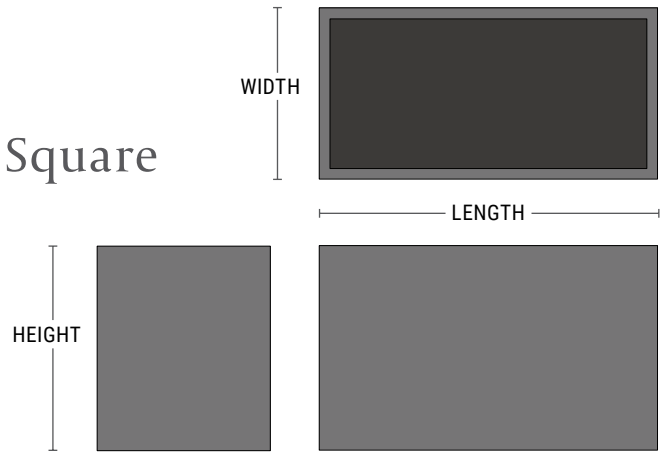

| PRODUCT | SHAPE | LENGTH | WIDTH | HEIGHT | WEIGHT (LBS.) | VOLUME (CUBIC FT.) | INTERIOR TOP | IRRIGATION |
|--------------|-----------|--------|-------|--------|---------------|--------------------|--------------|--------------------------|
| WWR-WS362442 | Rectangle | 36" | 24" | 42" | 196 lbs. | 20.15 | 33" x 21" | CWM-R2920-MS |
| WWR-WS363018 | Rectangle | 36" | 30" | 18" | 113 lbs. | 10.42 | 33" x 27" | CWM-R2914-MS |
| WWR-WS363024 | Rectangle | 36" | 30" | 24" | 137 lbs. | 14.13 | 33" x 27" | CWM-R2920-MS |
| WWR-WS363030 | Rectangle | 36" | 30" | 30" | 173 lbs. | 17.5 | 33" x 27" | CWM-R2920-MS |
| WWR-WS363036 | Rectangle | 36" | 30" | 36" | 196 lbs. | 21.53 | 33" x 27" | CWM-R2920-MS |
| WWR-WS363042 | Rectangle | 36" | 30" | 42" | 220 lbs. | 25.23 | 33" x 27" | CWM-R2920-MS |
| WWR-WS363618 | Square | 36" | 36" | 18" | 127 lbs. | 12.52 | 33" x 33" | CWM-R2914-MS |
| WWR-WS363624 | Square | 36" | 36" | 24" | 153 lbs. | 16.97 | 33" x 33" | CWM-R2920-MS |
| WWR-WS3600 | Square | 36" | 36" | 30" | 204 lbs. | 21 | 33" x 33" | CWM-R1620-2K/CWM-1720-4K |
| WWR-WS363636 | Square | 36" | 36" | 36" | 218 lbs. | 25.87 | 33" x 33" | CWM-R2920-MS |
| WWR-WS363642 | Square | 36" | 36" | 42" | 243 lbs. | 30.31 | 33" x 33" | CWM-R2920-MS |
| WWR-WS4200 | Square | 42" | 42" | 36" | 262 lbs. | 35.25 | 39" x 39" | CWM-R1120-4K/CWM-1720-4K |
| WWR-WS481012 | Rectangle | 48" | 10" | 12" | 65 lbs. | 2.95 | 45" x 7" | CWM-R1109-3K |
| WWR-WS481218 | Rectangle | 48" | 12" | 18" | 91 lbs. | 5.51 | 45" x 9" | CWM-R1614-2K |
| WWR-WS481818 | Rectangle | 48" | 18" | 18" | 107 lbs. | 8.31 | 45" x 15" | CWM-R2014-2K |
| WWR-WS481824 | Rectangle | 48" | 18" | 24" | 148 lbs. | 11 | 45" x 15" | CWM-R2014-2k |
| WWR-WS481830 | Rectangle | 48" | 18" | 30" | 166 lbs. | 14.22 | 45" x 15" | CWM-R2020-2K |
| WWR-WS482418 | Rectangle | 48" | 24" | 18" | 123 lbs. | 11.12 | 45" x 21" | CWM-R2014-2K |
| WWR-WS482424 | Rectangle | 48" | 24" | 24" | 169 lbs. | 14.5 | 45" x 21" | CWM-R2014-2k |
| WWR-WS482430 | Rectangle | 48" | 24" | 30" | 188 lbs. | 19.01 | 45" x 21" | CWM-R2020-2k |

Wilshire Planters Weathering Steel, Rectangle & Square

- 12-gauge A588 and A606 Steel
- Engineered to resist deformation
- Fully welded corners
- Optional toe kick available
- Drain holes standard

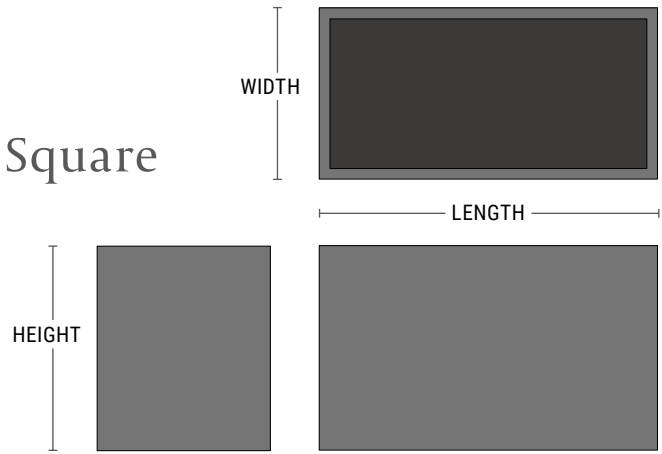

| PRODUCT | SHAPE | LENGTH | WIDTH | HEIGHT | WEIGHT (LBS.) | VOLUME (CUBIC FT.) | INTERIOR TOP | IRRIGATION |
|--------------|-----------|--------|-------|--------|---------------|--------------------|--------------|--------------|
| WWR-WS482436 | Rectangle | 48" | 24" | 36" | 213 lbs. | 22.96 | 45" x 21" | CWM-R2020-2k |
| WWR-WS482442 | Rectangle | 48" | 24" | 42" | 239 lbs. | 26.91 | 45" x 21" | CWM-R2020-2k |
| WWR-WS483018 | Rectangle | 48" | 30" | 18" | 139 lbs. | 13.92 | 45" x 27" | CWM-R2014-2k |
| WWR-WS483024 | Rectangle | 48" | 30" | 24" | 167 lbs. | 18.86 | 45" x 27" | CWM-R2020-2k |
| WWR-WS483030 | Rectangle | 48" | 30" | 30" | 219 lbs. | 23.5 | 45" x 27" | CWM-R2020-2k |
| WWR-WS483036 | Rectangle | 48" | 30" | 36" | 237 lbs. | 28.75 | 45" x 27" | CWM-R2020-2k |
| WWR-WS483042 | Rectangle | 48" | 30" | 42" | 265 lbs. | 33.69 | 45" x 27" | CWM-R2020-2k |
| WWR-WS483618 | Rectangle | 48" | 36" | 18" | 155 lbs. | 16.72 | 45" x 33" | CWM-R2014-2k |
| WWR-WS483624 | Rectangle | 48" | 36" | 24" | 185 lbs. | 22.66 | 45" x 33" | CWM-R2020-2k |
| WWR-WS483630 | Rectangle | 48" | 36" | 30" | 231 lbs. | 28.6 | 45" x 33" | CWM-R2020-2k |
| WWR-WS483636 | Rectangle | 48" | 36" | 36" | 261 lbs. | 34.54 | 45" x 33" | CWM-R2020-2k |
| WWR-WS483642 | Rectangle | 48" | 36" | 42" | 291 lbs. | 40.48 | 45" x 33" | CWM-R2020-2k |
| WWR-WS484818 | Rectangle | 48" | 48" | 18" | 187 lbs. | 22.33 | 45" x 45" | CWM-R2014-2k |
| WWR-WS484824 | Square | 48" | 48" | 24" | 239 lbs. | 30.25 | 45" x 45" | CWM-R2014-4K |
| WWR-WS484830 | Square | 48" | 48" | 30" | 274 lbs. | 38.19 | 45" x 45" | CWM-R2020-2k |
| WWR-WS484800 | Square | 48" | 48" | 36" | 344 lbs. | 45.5 | 45" x 45" | CWM-R2920-4k |
| WWR-WS484842 | Square | 48" | 48" | 42" | 342 lbs. | 54.05 | 45" x 45" | CWM-R2020-2k |
| WWR-WS601012 | Rectangle | 60" | 10" | 12" | 79 lbs. | 3.69 | 57" x 7" | CWM-R1109-3K |
| WWR-WS601218 | Rectangle | 60" | 12" | 18" | 110 lbs. | 6.89 | 57" x 9" | CWM-R1614-3K |
| WWR-WS601818 | Rectangle | 60" | 18" | 18" | 128 lbs. | 10.4 | 57" x 15" | CWM-R2014-2K |

Wilshire Planters Weathering Steel, Rectangle & Square

- 12-gauge A588 and A606 Steel
- Engineered to resist deformation
- Fully welded corners
- Optional toe kick available
- Drain holes standard

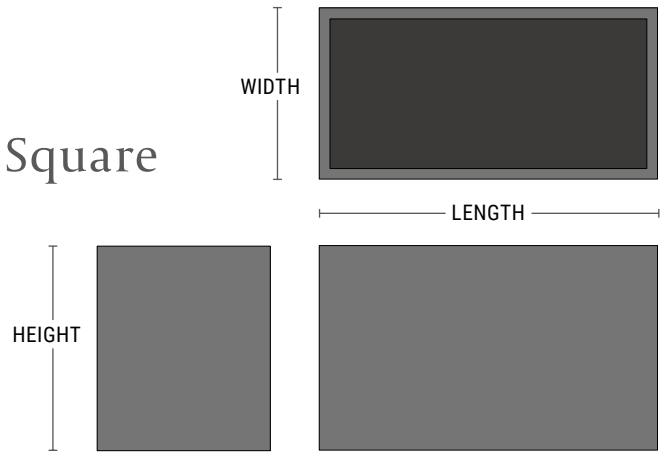

| PRODUCT | SHAPE | LENGTH | WIDTH | HEIGHT | WEIGHT (LBS.) | VOLUME (CUBIC FT.) | INTERIOR TOP | IRRIGATION |
|--------------|-----------|--------|-------|--------|---------------|--------------------|--------------|--------------|
| WWR-WS601824 | Rectangle | 60" | 18" | 24" | 177 lbs. | 14 | 57" x 15" | CWM-R2014-2k |
| WWR-WS601830 | Rectangle | 60" | 18" | 30" | 198 lbs. | 17.79 | 57" x 15" | CWM-R2020-2K |
| WWR-WS602418 | Rectangle | 60" | 24" | 18" | 146 lbs. | 13.91 | 57" x 21" | CWM-R2014-2K |
| WWR-WS602424 | Rectangle | 60" | 24" | 24" | 200 lbs. | 18.5 | 57" x 21" | CWM-R2014-2k |
| WWR-WS602430 | Rectangle | 60" | 24" | 30" | 222 lbs. | 23.78 | 57" x 21" | CWM-R2020-2k |
| WWR-WS602436 | Rectangle | 60" | 24" | 36" | 252 lbs. | 28.72 | 57" x 21" | CWM-R2020-2k |
| WWR-WS602442 | Rectangle | 60" | 24" | 42" | 298 lbs. | 33.66 | 57" x 21" | CWM-R2020-2k |
| WWR-WS603018 | Rectangle | 60" | 30" | 18" | 164 lbs. | 17.41 | 57" x 27" | CWM-R2014-2k |
| WWR-WS603024 | Rectangle | 60" | 30" | 24" | 197 lbs. | 23.6 | 57" x 27" | CWM-R2020-2k |
| WWR-WS603030 | Rectangle | 60" | 30" | 30" | 256 lbs. | 29 | 57" x 27" | CWM-R2020-2k |
| WWR-WS603036 | Rectangle | 60" | 30" | 36" | 278 lbs. | 35.97 | 57" x 27" | CWM-R2020-2k |
| WWR-WS603042 | Rectangle | 60" | 30" | 42" | 327 lbs. | 42.15 | 57" x 27" | CWM-R2020-2k |
| WWR-WS603618 | Rectangle | 60" | 36" | 18" | 183 lbs. | 20.92 | 57" x 33" | CWM-R2014-2k |
| WWR-WS603624 | Rectangle | 60" | 36" | 24" | 217 lbs. | 28.35 | 57" x 33" | CWM-R2020-2k |
| WWR-WS603630 | Rectangle | 60" | 36" | 30" | 269 lbs. | 35.78 | 57" x 33" | CWM-R2020-2k |
| WWR-WS603636 | Rectangle | 60" | 36" | 36" | 304 lbs. | 43.21 | 57" x 33" | CWM-R2020-2k |
| WWR-WS603642 | Rectangle | 60" | 36" | 42" | 356 lbs. | 50.64 | 57" x 33" | CWM-R2020-2k |
| WWR-WS604818 | Rectangle | 60" | 48" | 18" | 219 lbs. | 27.94 | 57" x 45" | CWM-R2014-2k |
| WWR-WS604824 | Rectangle | 60" | 48" | 24" | 257 lbs. | 37.86 | 57" x 45" | CWM-R2020-2k |
| WWR-WS604830 | Rectangle | 60" | 48" | 30" | 317 lbs. | 47.78 | 57" x 45" | CWM-R2020-2k |

Wilshire Planters Weathering Steel, Rectangle & Square

- 12-gauge A588 and A606 Steel
- Engineered to resist deformation
- Fully welded corners
- Optional toe kick available
- Drain holes standard

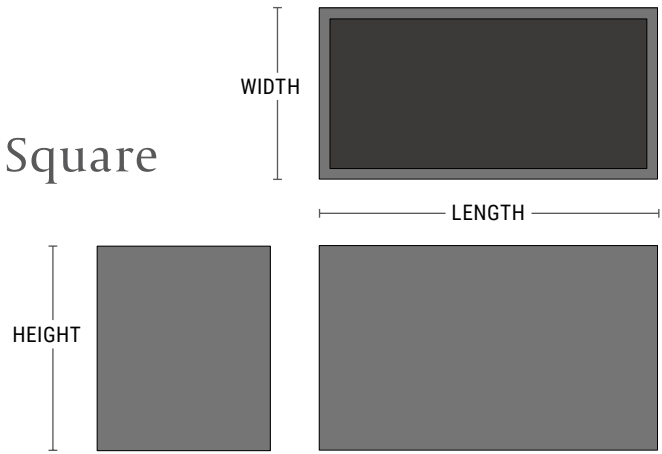

| PRODUCT | SHAPE | LENGTH | WIDTH | HEIGHT | WEIGHT (LBS.) | VOLUME (CUBIC FT.) | INTERIOR TOP | IRRIGATION |
|--------------|-----------|--------|-------|--------|---------------|--------------------|--------------|--------------|
| WWR-WS604836 | Rectangle | 60" | 48" | 36" | 355 lbs. | 57.7 | 57" x 45" | CWM-R2020-3k |
| WWR-WS604842 | Rectangle | 60" | 48" | 42" | 414 lbs. | 67.62 | 57" x 45" | CWM-R2020-2k |
| WWR-WS6000 | Square | 60" | 60" | 42" | 450 lbs. | 84.5 | 57" x 57" | CWM-2920-4K |
| WWR-WS721012 | Rectangle | 72" | 10" | 12" | 93 lbs. | 4.43 | 69" x 7" | CWM-R1109-4K |
| WWR-WS721218 | Rectangle | 72" | 12" | 18" | 129 lbs. | 8.28 | 69" x 9" | CWM-R1614-3K |
| WWR-WS721818 | Rectangle | 72" | 18" | 18" | 149 lbs. | 12.49 | 69" x 15" | CWM-R2014-3K |
| WWR-WS721824 | Rectangle | 72" | 18" | 24" | 210 lbs. | 16.5 | 69" x 15" | CWM-R2014-3k |
| WWR-WS721830 | Rectangle | 72" | 18" | 30" | 231 lbs. | 21.36 | 69" x 15" | CWM-R2020-3K |
| WWR-WS722418 | Rectangle | 72" | 24" | 18" | 170 lbs. | 16.7 | 69" x 21" | CWM-R2014-3K |
| WWR-WS722424 | Rectangle | 72" | 24" | 24" | 238 lbs. | 22 | 69" x 21" | CWM-R2014-3k |
| WWR-WS722430 | Rectangle | 72" | 24" | 30" | 257 lbs. | 28.56 | 69" x 21" | CWM-R2020-3k |
| WWR-WS722436 | Rectangle | 72" | 24" | 36" | 291 lbs. | 34.49 | 69" x 21" | CWM-R2020-3k |
| WWR-WS722442 | Rectangle | 72" | 24" | 42" | 343 lbs. | 40.42 | 69" x 21" | CWM-R2020-3k |
| WWR-WS723018 | Rectangle | 72" | 30" | 18" | 190 lbs. | 20.91 | 69" x 27" | CWM-R2014-3k |
| WWR-WS723024 | Rectangle | 72" | 30" | 24" | 226 lbs. | 28.34 | 69" x 27" | CWM-R2020-3k |
| WWR-WS723030 | Rectangle | 72" | 30" | 30" | 301 lbs. | 35 | 69" x 27" | CWM-R2020-3k |
| WWR-WS723036 | Rectangle | 72" | 30" | 36" | 319 lbs. | 43.19 | 69" x 27" | CWM-R2020-3k |
| WWR-WS723042 | Rectangle | 72" | 30" | 42" | 375 lbs. | 50.61 | 69" x 27" | CWM-R2020-3k |
| WWR-WS723618 | Rectangle | 72" | 36" | 18" | 210 lbs. | 25.12 | 69" x 33" | CWM-R2014-3k |
| WWR-WS723624 | Rectangle | 72" | 36" | 24" | 249 lbs. | 34.04 | 69" x 33" | CWM-R2020-3k |

Wilshire Planters Weathering Steel, Rectangle & Square

- 12-gauge A588 and A606 Steel
- Engineered to resist deformation
- Fully welded corners
- Optional toe kick available
- Drain holes standard

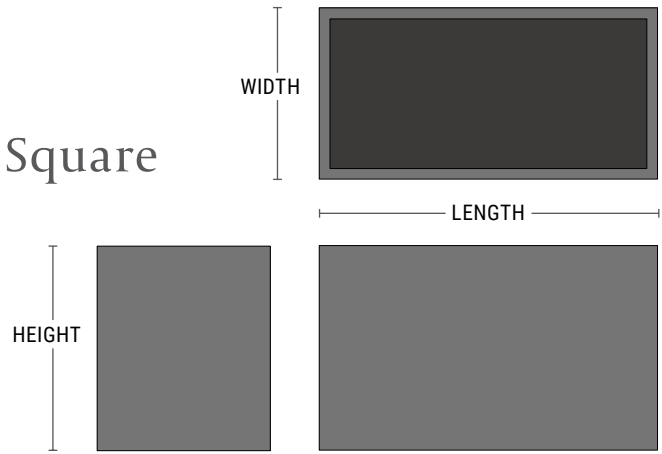

| PRODUCT | SHAPE | LENGTH | WIDTH | HEIGHT | WEIGHT (LBS.) | VOLUME (CUBIC FT.) | INTERIOR TOP | IRRIGATION |
|--------------|-----------|--------|-------|--------|---------------|--------------------|--------------|--------------|
| WWR-WS723630 | Rectangle | 72" | 36" | 30" | 308 lbs. | 42.96 | 69" x 33" | CWM-R2020-3k |
| WWR-WS723636 | Rectangle | 72" | 36" | 36" | 347 lbs. | 51.89 | 69" x 33" | CWM-R2020-3k |
| WWR-WS723642 | Rectangle | 72" | 36" | 42" | 406 lbs. | 60.81 | 69" x 33" | CWM-R2020-3k |
| WWR-WS724818 | Rectangle | 72" | 48" | 18" | 251 lbs. | 33.54 | 69" x 45" | CWM-R2014-3k |
| WWR-WS724824 | Rectangle | 72" | 48" | 24" | 294 lbs. | 45.46 | 69" x 45" | CWM-R2020-3k |
| WWR-WS724830 | Rectangle | 72" | 48" | 30" | 360 lbs. | 57.37 | 69" x 45" | CWM-R2020-3k |
| WWR-WS724836 | Rectangle | 72" | 48" | 36" | 403 lbs. | 69.28 | 69" x 45" | CWM-R2020-3k |
| WWR-WS724842 | Rectangle | 72" | 48" | 42" | 468 lbs. | 81.19 | 69" x 45" | CWM-R2020-3k |
| WWR-WS7200 | Square | 72" | 72" | 30" | 566 lbs. | 122 | 69" x 69" | CWM-2920-4KE |
| WWR-WS961012 | Rectangle | 96" | 10" | 12" | 121 lbs. | 5.91 | 93" x 7" | CWM-R1109-5k |
| WWR-WS961218 | Rectangle | 96" | 12" | 18" | 167 lbs. | 11.04 | 93" x 9" | CWM-R1614-4K |
| WWR-WS961818 | Rectangle | 96" | 18" | 18" | 192 lbs. | 16.66 | 93" x 15" | CWM-R2014-3K |
| WWR-WS961824 | Rectangle | 96" | 18" | 24" | 267 lbs. | 22 | 93" x 15" | CWM-R2014-4k |
| WWR-WS961830 | Rectangle | 96" | 18" | 30" | 317 lbs. | 28.5 | 93" x 15" | CWM-R2020-3K |
| WWR-WS962418 | Rectangle | 96" | 24" | 18" | 217 lbs. | 22.28 | 93" x 21" | CWM-R2014-3K |
| WWR-WS962424 | Rectangle | 96" | 24" | 24" | 299 lbs. | 29.5 | 93" x 21" | CWM-R2014-4k |
| WWR-WS962430 | Rectangle | 96" | 24" | 30" | 348 lbs. | 38.11 | 93" x 21" | CWM-R2020-4k |
| WWR-WS962436 | Rectangle | 96" | 24" | 36" | 391 lbs. | 46.02 | 93" x 21" | CWM-R2020-4k |
| WWR-WS962442 | Rectangle | 96" | 24" | 42" | 457 lbs. | 53.93 | 93" x 21" | CWM-R2020-4k |
| WWR-WS963018 | Rectangle | 96" | 30" | 18" | 241 lbs. | 27.9 | 93" x 27" | CWM-R2014-4k |

Wilshire Planters Weathering Steel, Rectangle & Square

- 12-gauge A588 and A606 Steel
- Engineered to resist deformation
- Fully welded corners
- Optional toe kick available
- Drain holes standard

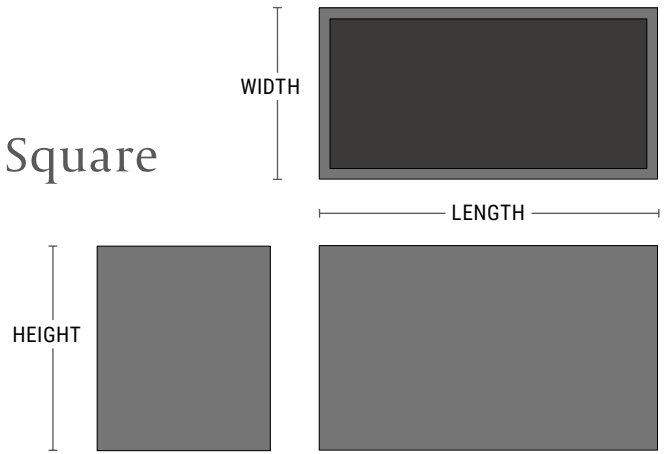

| PRODUCT | SHAPE | LENGTH | WIDTH | HEIGHT | WEIGHT (LBS.) | VOLUME (CUBIC FT.) | INTERIOR TOP | IRRIGATION |
|--------------|-----------|--------|-------|--------|---------------|--------------------|--------------|--------------|
| WWR-WS963024 | Rectangle | 96" | 30" | 24" | 311 lbs. | 37.81 | 93" x 27" | CWM-R2020-4k |
| WWR-WS963030 | Rectangle | 96" | 30" | 30" | 375 lbs. | 46.5 | 93" x 27" | CWM-R2020-4k |
| WWR-WS963036 | Rectangle | 96" | 30" | 36" | 425 lbs. | 57.62 | 93" x 27" | CWM-R2020-4k |
| WWR-WS963042 | Rectangle | 96" | 30" | 42" | 494 lbs. | 67.53 | 93" x 27" | CWM-R2020-4k |
| WWR-WS963618 | Rectangle | 96" | 36" | 18" | 266 lbs. | 33.52 | 93" x 33" | CWM-R2014-4k |
| WWR-WS963624 | Rectangle | 96" | 36" | 24" | 338 lbs. | 45.42 | 93" x 33" | CWM-R2020-4k |
| WWR-WS963630 | Rectangle | 96" | 36" | 30" | 411 lbs. | 57.33 | 93" x 33" | CWM-R2020-4k |
| WWR-WS963636 | Rectangle | 96" | 36" | 36" | 458 lbs. | 69.23 | 93" x 33" | CWM-R2020-4k |
| WWR-WS963642 | Rectangle | 96" | 36" | 42" | 531 lbs. | 81.14 | 93" x 33" | CWM-R2020-4k |
| WWR-WS964818 | Rectangle | 96" | 48" | 18" | 315 lbs. | 44.76 | 93" x 45" | CWM-R2014-4k |
| WWR-WS964824 | Rectangle | 96" | 48" | 24" | 394 lbs. | 60.65 | 93" x 45" | CWM-R2020-4k |
| WWR-WS964830 | Rectangle | 96" | 48" | 30" | 474 lbs. | 76.55 | 93" x 45" | CWM-R2020-4k |
| WWR-WS964836 | Rectangle | 96" | 48" | 36" | 525 lbs. | 92.44 | 93" x 45" | CWM-R2020-4k |
| WWR-WS964842 | Rectangle | 96" | 48" | 42" | 604 lbs. | 108.34 | 93" x 45" | CWM-R2020-4k |



Wilshire Planters Weathering Steel, Round

Weathering Steel planters offer a warm industrial aesthetic favored by many landscape architects. The natural red-orange oxidization forms a protective patina that develops and regenerates continuously. Our A588 and A606 grade steel planters are meticulously assembled and welded.

Weathering Steel or Pre-Weathered Steel

Our Weathering Steel ships with a natural mill scale finish. The initial oxidation develops within weeks and evolves over time. Pre-Weathered Steel products undergo an earth-friendly pre-treatment, which steps up the oxidation process timeline to help achieve the desired visual result faster.

Wilshire Planters, Weathering Steel, Round

WILSHIRE PLANTERS, WEATHERING STEEL ROUND

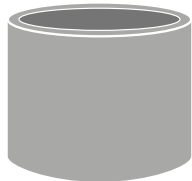

Round

THE COMPLETE WILSHIRE COLLECTION

For additional shapes and materials, visit tournesol.com/collections/wilshire

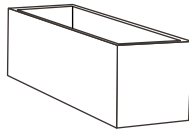

Rectangle

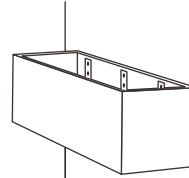

Hanging Box

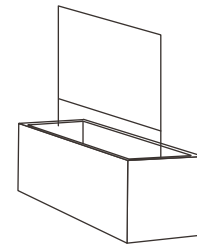

Trellis, Laser-Cut Screen

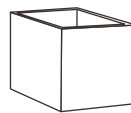

Square

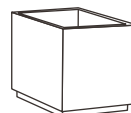

Toe Kick

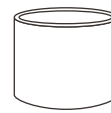

Round



Round with Toe Kick

OPTIONS

Standard Wilshire Planters can be modified with a broad array of options without incurring custom charges. Options are limited to those products that can support them. Speak to a Tournesol Advisor to discuss which options will work with your project.



Irrigation



Change Dimension



Casters



Drain Holes



Toe Kick



False Bottom



Tie Downs



Pre-Weathering Treatment

Wilshire Planters, Weathering Steel, Round

Weathering Steel

Our Weathering Steel ships with a natural mill scale finish. The initial oxidation develops within weeks and evolves over time. Environmental conditions such as humidity, salt, and the temperature at installation can affect rust uniformity and formation rate. The color develops from a vibrant orange to a deep reddish-brown.

Pre-Weathered Steel

Our Pre-Weathered Steel products undergo an earth-friendly pre-treatment, which steps up the oxidation process timeline to help achieve the desired visual result faster.

Our process begins by grit-blasting the raw mill scale surface; next we treat it with an all-natural solution of hydrogen peroxide, vinegar, and salt. Treated products cure for a day before being individually wrapped in paper and then plastic before shipping.

Raw mill scale steel and treated surfaces can be powdery and may show markings during delivery and installation. These changes are affected by humidity levels and storage.

Weathering Steel products should be unwrapped upon arrival and stored indoors if possible. Shedding during unpacking and storing may occur; protect flooring during storage and installation.

TOP LIP

Wilshire Planters in Weathering Steel come with a standard lip return.

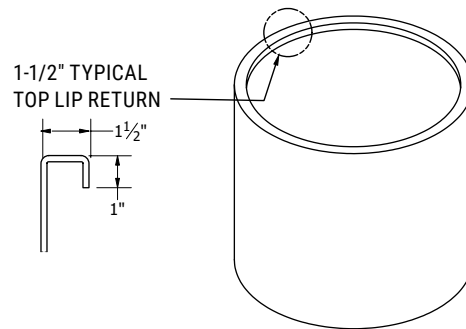

BASE OPTION

See Wilshire Weathering Steel Round with Toe-kick Planters, if toe kick is desired.

DRAINAGE

Drain Holes: Standard drain holes are 1-5/8" diameter, made free-of-charge at the factory.

Wilshire Planters, Weathering Steel Round

- Fully welded 12-gauge weathering steel
- Engineered to resist deformation
- Protective weathering patina
- Optional toe kick available
- Drain holes standard

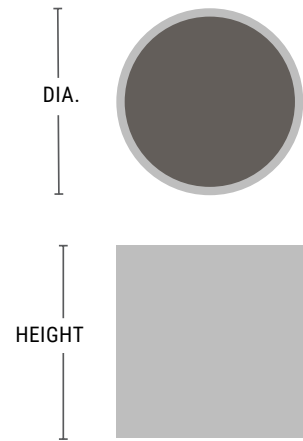

| PRODUCT | SHAPE | DIA. | HEIGHT | WEIGHT (LBS.) | VOLUME (CUBIC FT.) | INTERIOR TOP | INTERIOR BOTTOM | IRRIGATION |
|-------------|-------|---------|--------|---------------|--------------------|--------------|-----------------|----------------------|
| WWS-WS1800F | Round | 18" dia | 20" | 52 | 3 | 15" dia | 14.5" dia | CWC-1216 |
| WWS-WS2400F | Round | 24" dia | 24" | 84 | 6 | 21" dia | 20.5" dia | CWC-1600/CWM-1114-2k |
| WWS-WS3000F | Round | 30" dia | 27" | 117 | 11 | 27" dia | 25.5" dia | CWC-2400/CWM-1720-2k |
| WWS-WS3600F | Round | 36" dia | 30" | 163 | 17 | 33" dia | 31.5" dia | CWM-1720-3k |
| WWS-WS4200F | Round | 42" dia | 33" | 210 | 26 | 39" dia | 37.5" dia | CWM-1720-3k |
| WWS-WS4800F | Round | 48" dia | 36" | 261 | 37 | 45" dia | 43.5" dia | CWM-2920-3k |
| WWS-WS6000F | Round | 60" dia | 36" | 347 | 57 | 57" dia | 55.5" dia | CWM-2920-4k |
| WWS-WS7200F | Round | 72" dia | 42" | 489 | 96 | 69" dia | 67.5" dia | CWM-2920-5k |



Wilshire Planters Weathering Steel, Round with Toe Kick

Weathering Steel planters offer a warm industrial aesthetic favored by many landscape architects. The natural red-orange oxidization forms a protective patina that develops and regenerates continuously. Our A588 and A606 grade steel planters are meticulously assembled and welded.

Weathering Steel or Pre-Weathered Steel

Our Weathering Steel ships with a natural mill scale finish. The initial oxidation develops within weeks and evolves over time. Pre-Weathered Steel products undergo an earth-friendly pre-treatment, which steps up the oxidation process timeline to help achieve the desired visual result faster.

Wilshire Planters, Weathering Steel, Round with Toe Kick

WILSHIRE PLANTERS,
WEATHERING STEEL
WITH TOE KICK

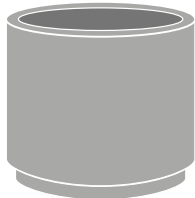

Round with Toe Kick

THE COMPLETE WILSHIRE COLLECTION
For additional shapes and materials, visit
tournesol.com/collections/wilshire

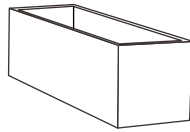

Rectangle

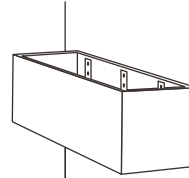

Hanging Box

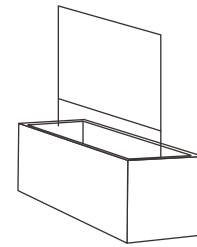

Trellis, Laser-Cut Screen

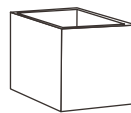

Square

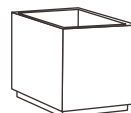

Toe Kick

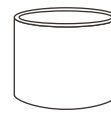

Round



Round with Toe Kick

OPTIONS

Standard Wilshire Planters can be modified with a broad array of options without incurring custom charges. Options are limited to those products that can support them. Speak to a Tournesol Advisor to discuss which options will work with your project.



Irrigation



Change Dimension



Casters



Drain Holes



False Bottom



Tie Downs



Pre-Weathering Treatment

Wilshire Planters, Weathering Steel, Round with Toe Kick

Weathering Steel

Our Weathering Steel ships with a natural mill scale finish. The initial oxidation develops within weeks and evolves over time. Environmental conditions such as humidity, salt, and the temperature at installation can affect rust uniformity and formation rate. The color develops from a vibrant orange to a deep reddish-brown.

Pre-Weathered Steel

Our Pre-Weathered Steel products undergo an earth-friendly pre-treatment, which steps up the oxidation process timeline to help achieve the desired visual result faster.

Our process begins by grit-blasting the raw mill scale surface; next we treat it with an all-natural solution of hydrogen peroxide, vinegar, and salt. Treated products cure for a day before being individually wrapped in paper and then plastic before shipping.

Raw mill scale steel and treated surfaces can be powdery and may show markings during delivery and installation. These changes are affected by humidity levels and storage.

Weathering Steel products should be unwrapped upon arrival and stored indoors if possible. Shedding during unpacking and storing may occur; protect flooring during storage and installation.

TOP LIP

Wilshire Planters in Weathering Steel comes with a standard lip return.

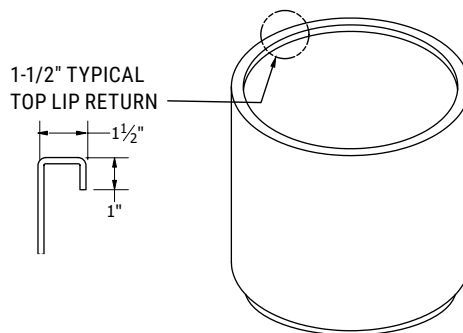

BASE OPTION

See Wilshire Planters in Weathering Steel Round if no Toe Kick is desired. Wilshire Weathering Steel Planters are available with a toe kick option.

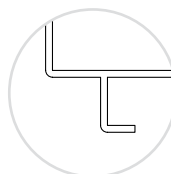

WWR-RE

Toe kick option
2"H bottom reveal

DRAINAGE

Drain Holes: Standard drain holes are 1-5/8" diameter, made free-of-charge at the factory.

Wilshire Planters Weathering Steel, Round with Toe Kick

- Fully welded 12-gauge weathering steel
- Engineered to resist deformation
- Protective weathering patina
- Toe kick visually lifts planter
- Drain holes standard

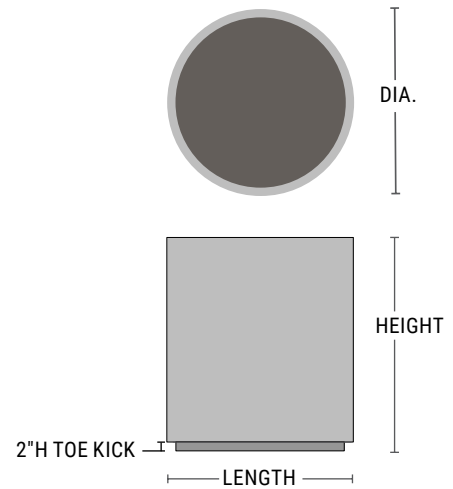

| PRODUCT | SHAPE | DIA. | HEIGHT | WEIGHT (LBS.) | VOLUME (CUBIC FT.) | INTERIOR TOP | INTERIOR BOTTOM | IRRIGATION |
|-------------|----------------------|---------|--------|---------------|--------------------|--------------|-----------------|----------------------|
| WWS-WS1800 | Toe Kick Round | 18" dia | 20" | 52 | 3 | 15" dia | 14" dia | CWC-1216 |
| WWST-WS1800 | Toe Kick Round, Tall | 18" dia | 30" | 71 | 4 | 15" dia | 14" dia | CWI-1200 |
| WWS-WS2400 | Toe Kick Round | 24" dia | 24" | 84 | 6 | 21" dia | 20" dia | CWC-1600/CWM-1114-2k |
| WWST-WS2400 | Toe Kick Round, Tall | 24" dia | 48" | 147 | 12 | 21" dia | 20" dia | CWI-1700 |
| WWS-WS3000 | Toe Kick Round | 30" dia | 27" | 117 | 11 | 27" dia | 26" dia | CWC-2400/CWM-1720-2k |
| WWST-WS3000 | Toe Kick Round, Tall | 30" dia | 54" | 209 | 21 | 27" dia | 26" dia | CWI-2200 |
| WWS-WS3600 | Toe Kick Round | 36" dia | 30" | 163 | 17 | 33" dia | 32" dia | CWM-1720-3k |
| WWS-WS4200 | Toe Kick Round | 42" dia | 33" | 210 | 25 | 33" dia | 32" dia | CWM-1720-3k |
| WWS-WS4800 | Toe Kick Round | 48" dia | 36" | 261 | 36 | 45" dia | 44" dia | CWM-2920-3k |
| WWS-WS6000 | Toe Kick Round | 60" dia | 36" | 347 | 56 | 57" dia | 56" dia | CWM-2920-4k |
| WWS-WS7200 | Toe Kick Round | 72" dia | 42" | 489 | 94 | 69" dia | 68" dia | CWM-2920-5k |