

---

## Camino Design Guide

# Camino Design Guide

## INTRODUCTION

Camino is a modular bench collection designed to create vibrant outdoor gathering spaces. Connecting benches enables architectural scalability. Optional integrated lighting illuminates outdoor evening activities. Made in Port Orchard, WA, Camino is constructed from powder-coated steel and domestically sourced thermally modified hardwood.

This design guide is intended to inspire and kick-start the design process. It provides information about designing with Camino and functional Configurations which include plan views, parts lists, and downloadable models.

## ADDITIONAL RESOURCES

Materials, dimensions, weights, and lighting details can be found in the *Camino Product Details*.

Additional drawings and models available at [tournesol.com/camino\\_models](https://tournesol.com/camino_models).

Our team of advisors is available to provide guidance and answer questions. [tournesol.com/advisors](https://tournesol.com/advisors).

## TABLE OF CONTENTS

### Camino Basics

Pages 3-5

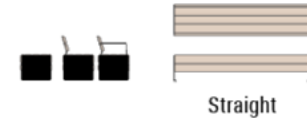

### Camino Lighting

Page 6



### Pairing with Planters

Page 7



### Thought Starters

Pages 8-9

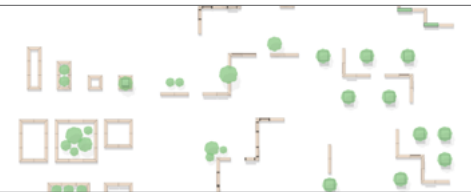

### Configurations

Pages 10-21

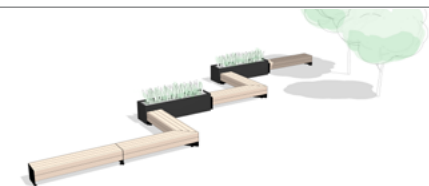

# Camino Basics: Making Connections

## STRAIGHT BENCHES

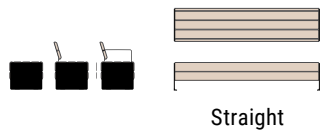

## 45° BENCHES

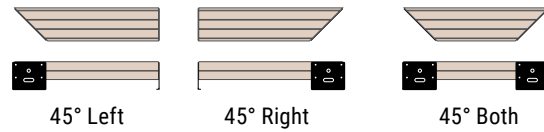

## 60° BENCHES

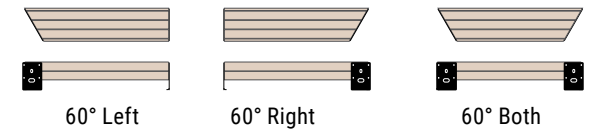

## EDGES & ENDS

Understanding Long vs. Short Edge will make Left vs. Right easier to identify.

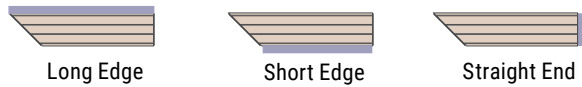

## LEFT, RIGHT & BOTH

Left and Right benches can be identified by facing the Short Edge of the bench.

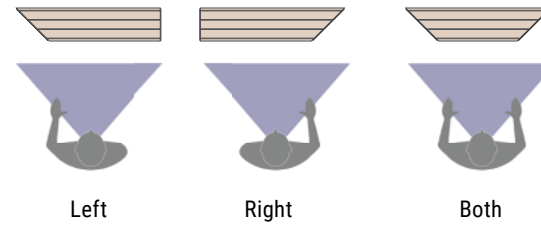

## BACKS, ARMS, INHIBITORS

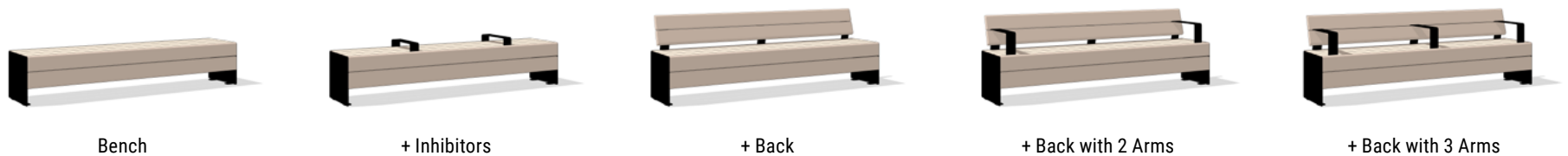

# Camino Basics: Making Connections

Camino benches have two types of ends: straight finished ends and joiner ends. Joiner ends feature holes and cutouts for connecting benches and passing lighting cables through. All angled ends are joiner ends. In the illustrations below, **green represents a joiner end** that can be connected to another bench. **Red represents a finished end.**

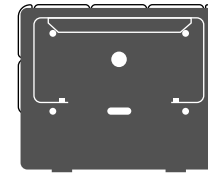

Joiner End

## END OPTIONS: STRAIGHT



2 joiner ends



1 joiner & 1 finished



2 finished ends

## END OPTIONS: 45° or 60° LEFT OR RIGHT



2 joiner ends



1 joiner & 1 finished

## END OPTIONS: 45° or 60° BOTH



2 joiner ends

## CONNECTING BENCHES



Straight Straight

## CONNECTING 45° BENCHES

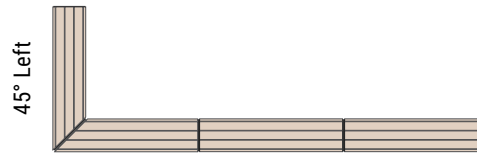

45° Left  
45° Right  
Straight Straight

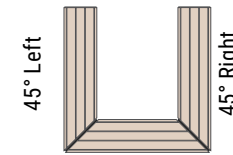

45° Left  
45° Right  
45° Both

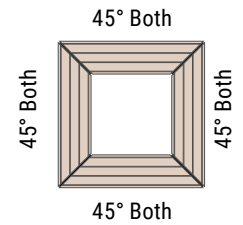

45° Both  
45° Both  
45° Both  
45° Both

## CONNECTING 60° BENCHES

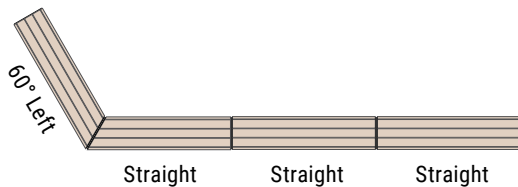

60° Left  
60° Right  
Straight Straight Straight

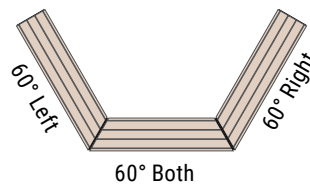

60° Left  
60° Right  
60° Both

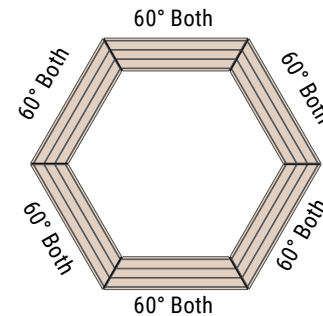

60° Both  
60° Both  
60° Both  
60° Both  
60° Both  
60° Both



# Camino Basics: Making Connections

## EXPANDING ON CONNECTIONS

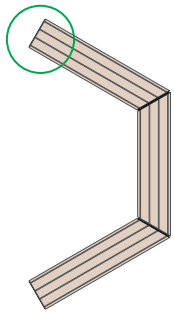

Open ends should be straight ends

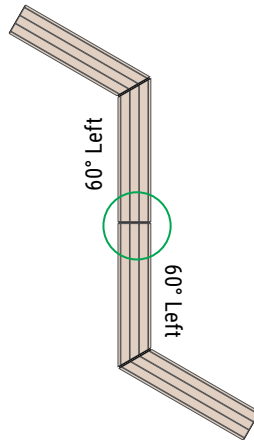
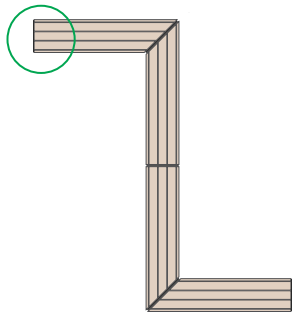

To reverse direction, use Left or Right benches and connect at straight ends

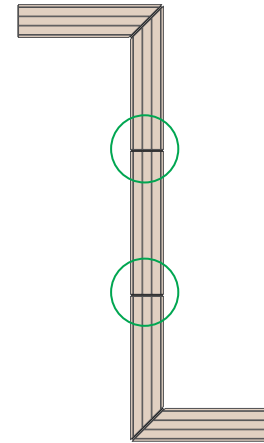

Extend length by adding a straight bench

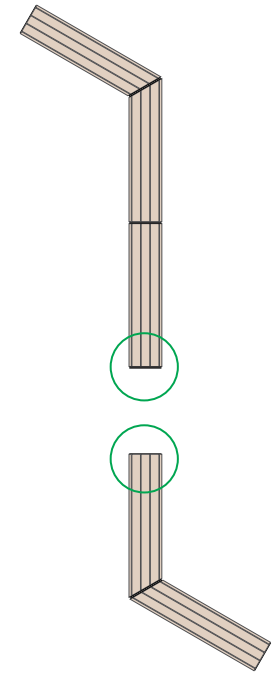

Create openings for people to pass through

## SUCCESSFUL CONNECTIONS:

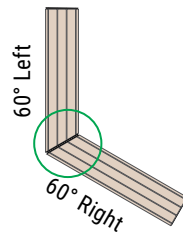
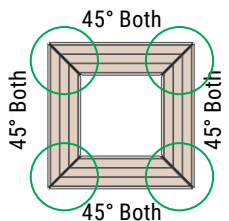
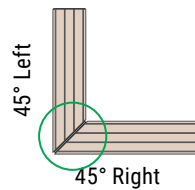
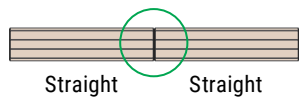

## UNSUCCESSFUL CONNECTIONS:

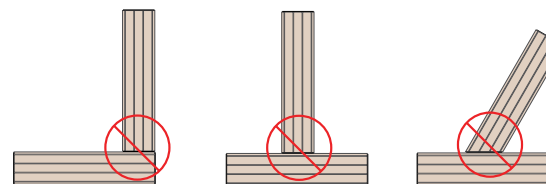
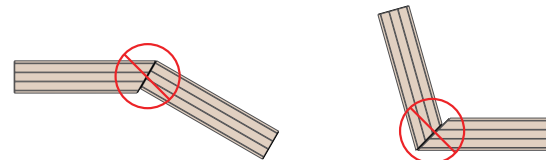

# Camino Lighting

## LED LIGHTING

Optional LED Lighting is available for Camino Benches. The system is easy to set up and illuminates nighttime activities. 2700K, UL and wet rated. Camino lighting is DarkSky Approved. For more info refer to submittal drawing.

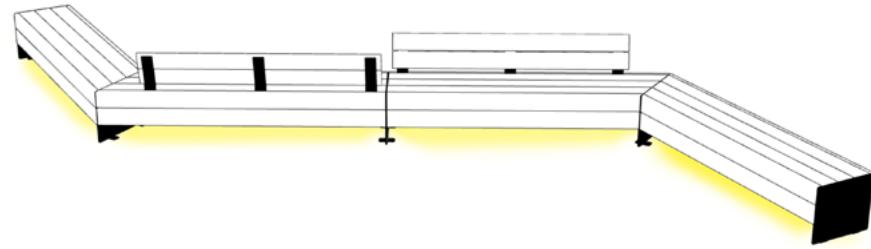

## MOUNTING & CONNECTIONS USING JOINER ENDS

Joiner Ends have openings for fastening bolts, and facilitate the pass through of lighting and electrical connections.

Mounting Brackets for LED Drivers and Light Bar Trays connect to Joiner Ends hidden inside the bench.

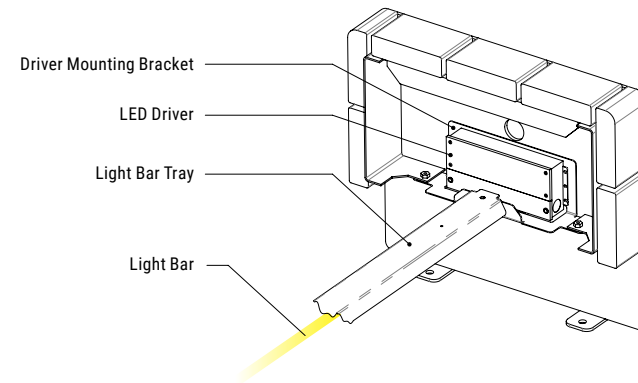

## STARTER KITS & ADDER KITS

Begin with a Starter Kit which includes an LED driver, driver mounting bracket, tray, light bar, and connectors. If connecting additional benches, connect up to three Adder Kits. If additional lighting is needed, add a new Starter Kit and continue adding up to three Adder Kits. Starter Kits can be daisy-chained from one power location by running cable through openings in Joiner Ends above Lighting Kits.

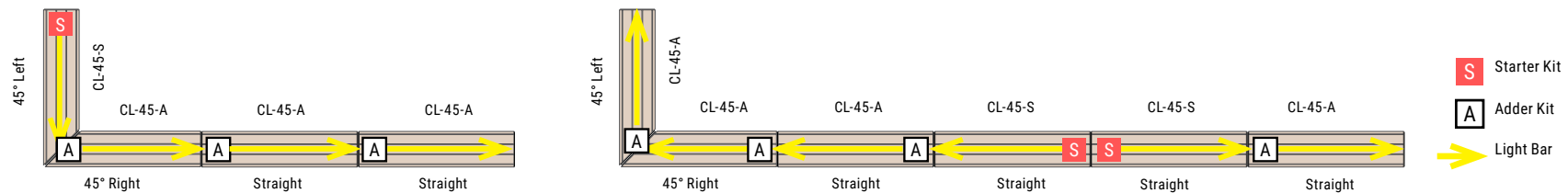

# Pairing Camino with Planters

## ADDING WILSHIRE PLANTERS

Camino Modular Benches are designed to support large-scale landscapes—working well with planted trees and planters. Using Wilshire square and rectangular planters in conjunction with Camino, extends spacemaking capabilities, adding interest, privacy, and shade.

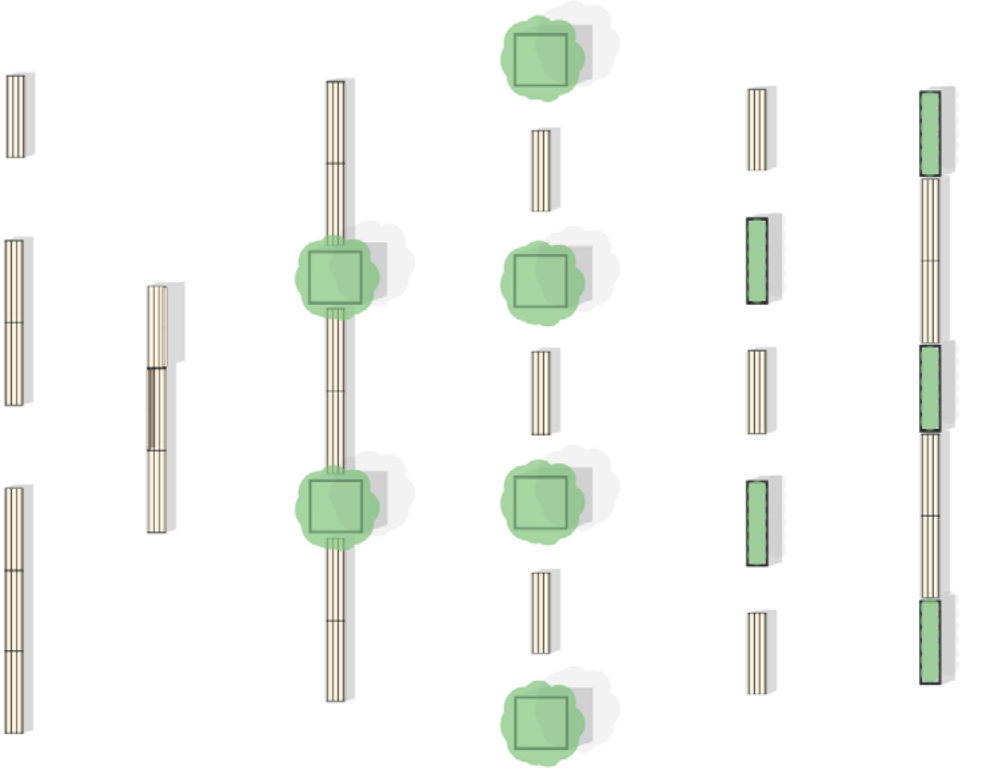
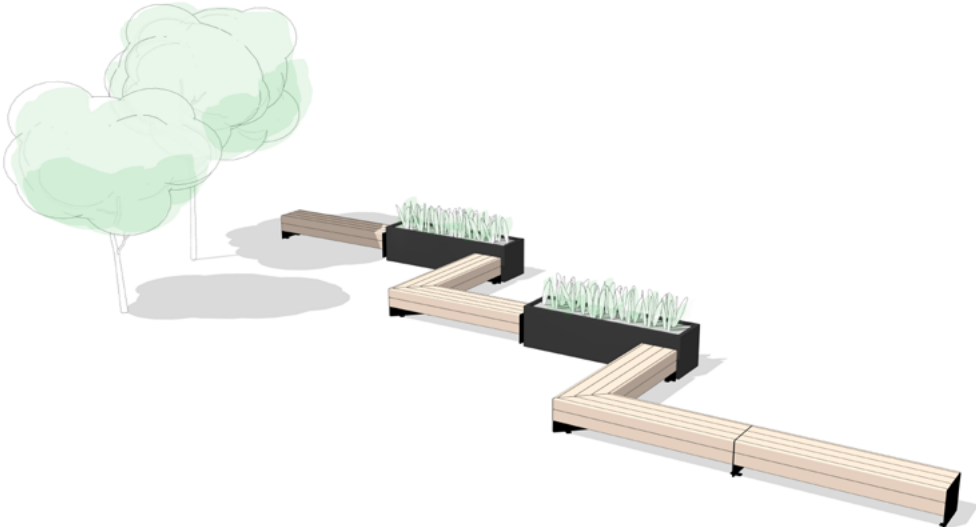
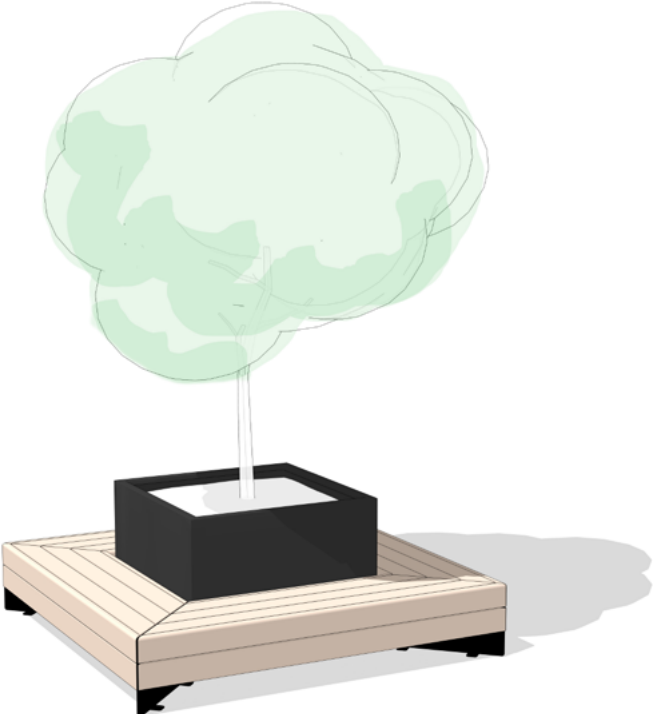

# Camino Thought Starters

CREATE 90° CORNERS BY CONNECTING 45° BENCHES

BELOW ARE A FEW THOUGHT STARTERS

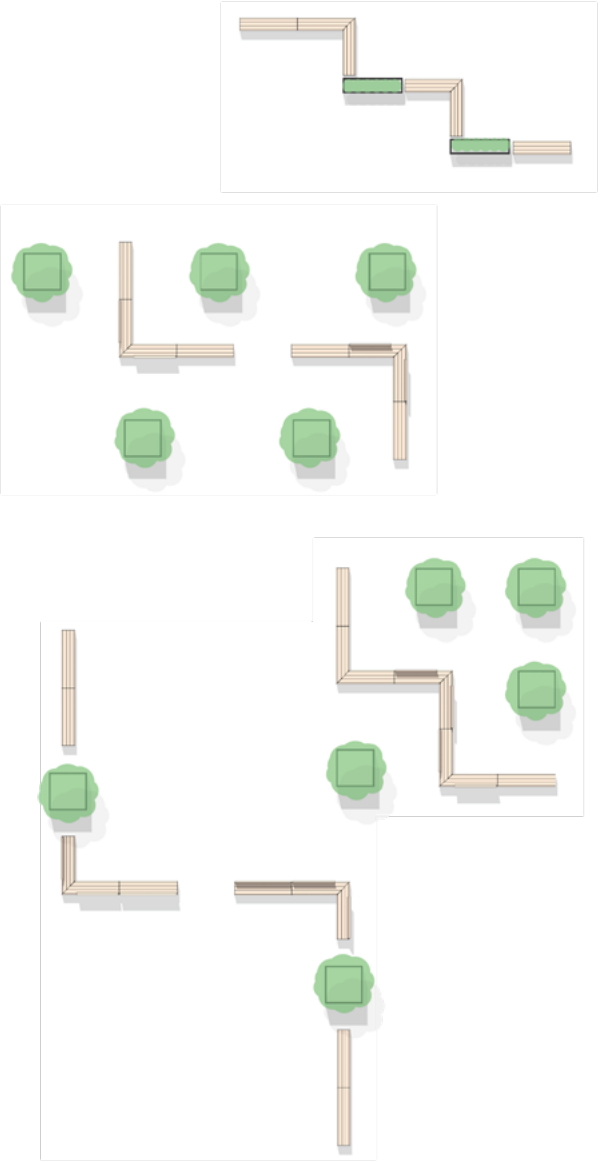
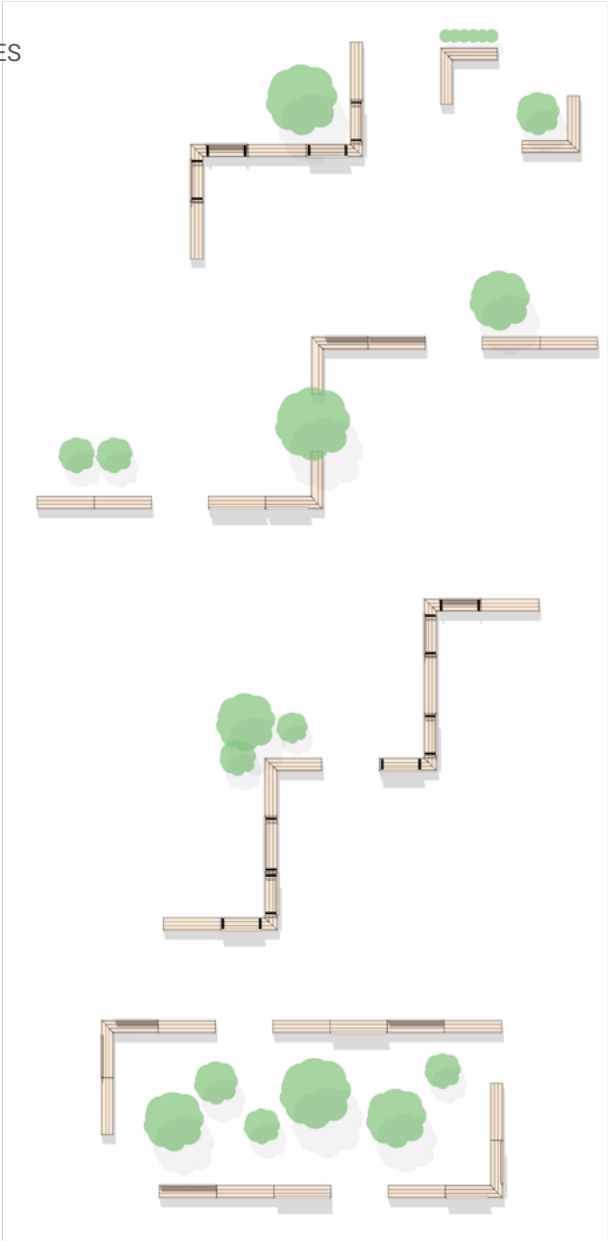
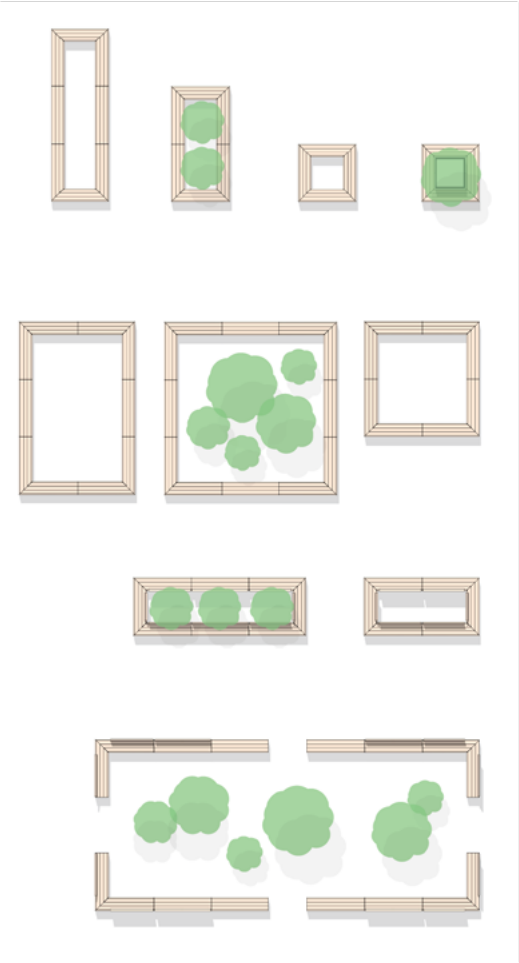

# Camino Thought Starters

CREATE 120° CORNERS BY CONNECTING 60° BENCHES

BELOW ARE A FEW THOUGHT STARTERS

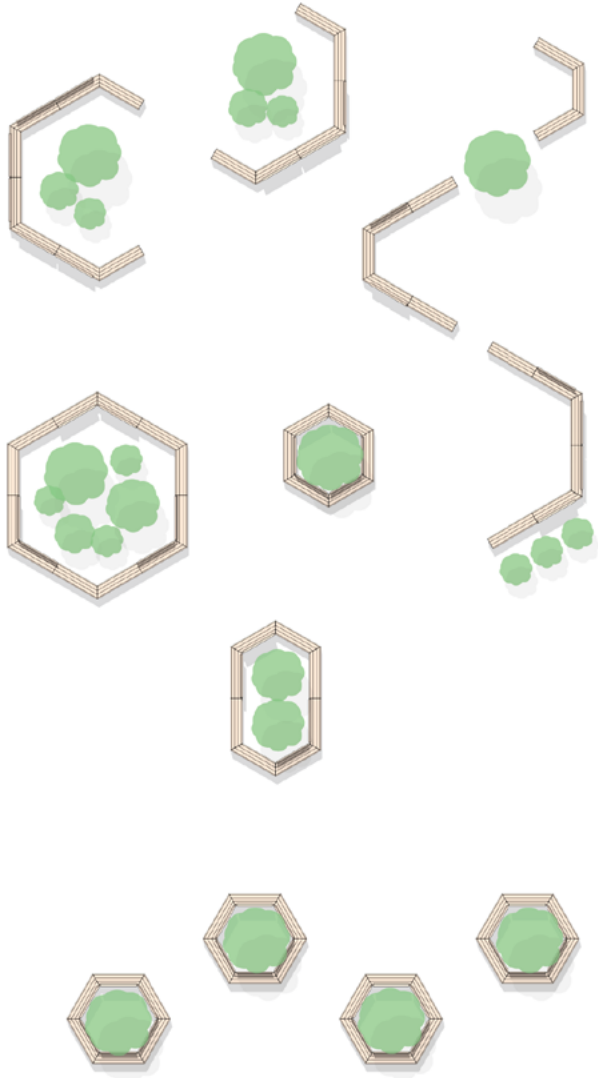
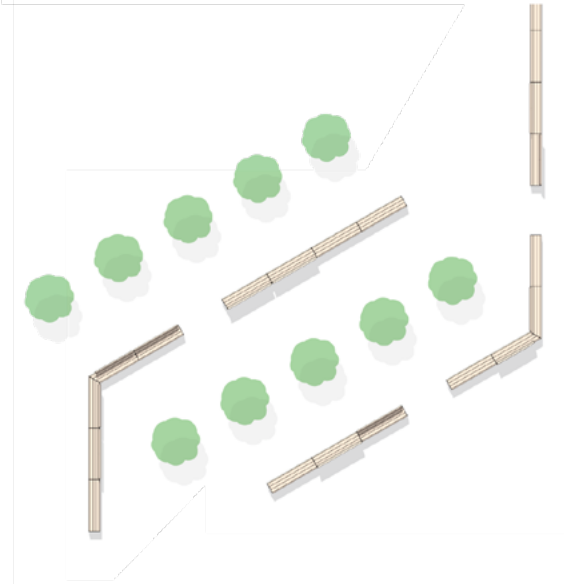
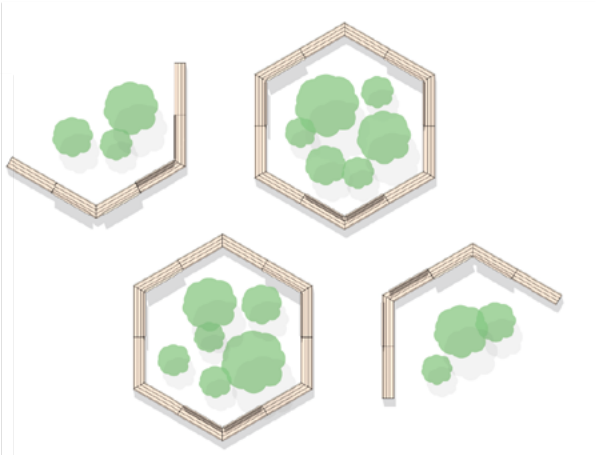
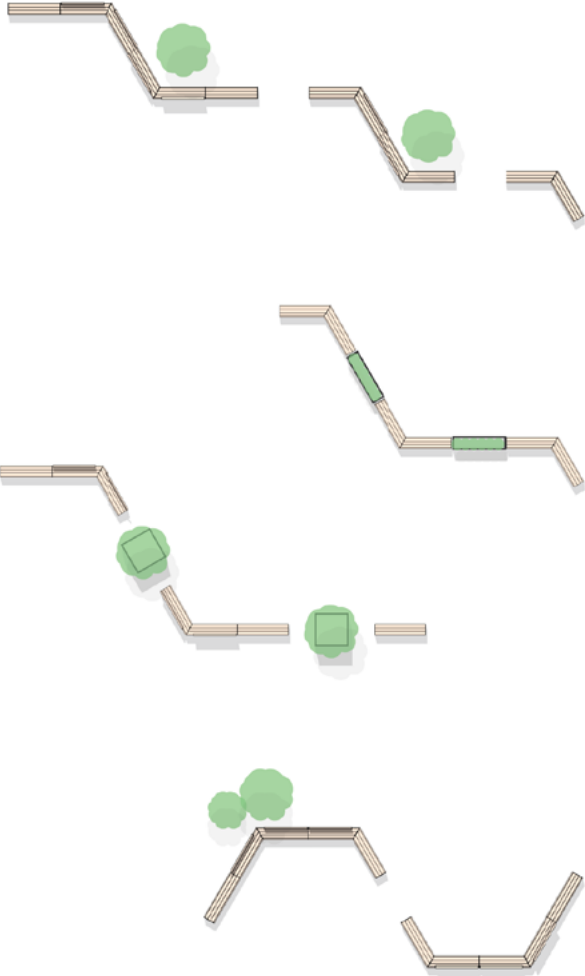

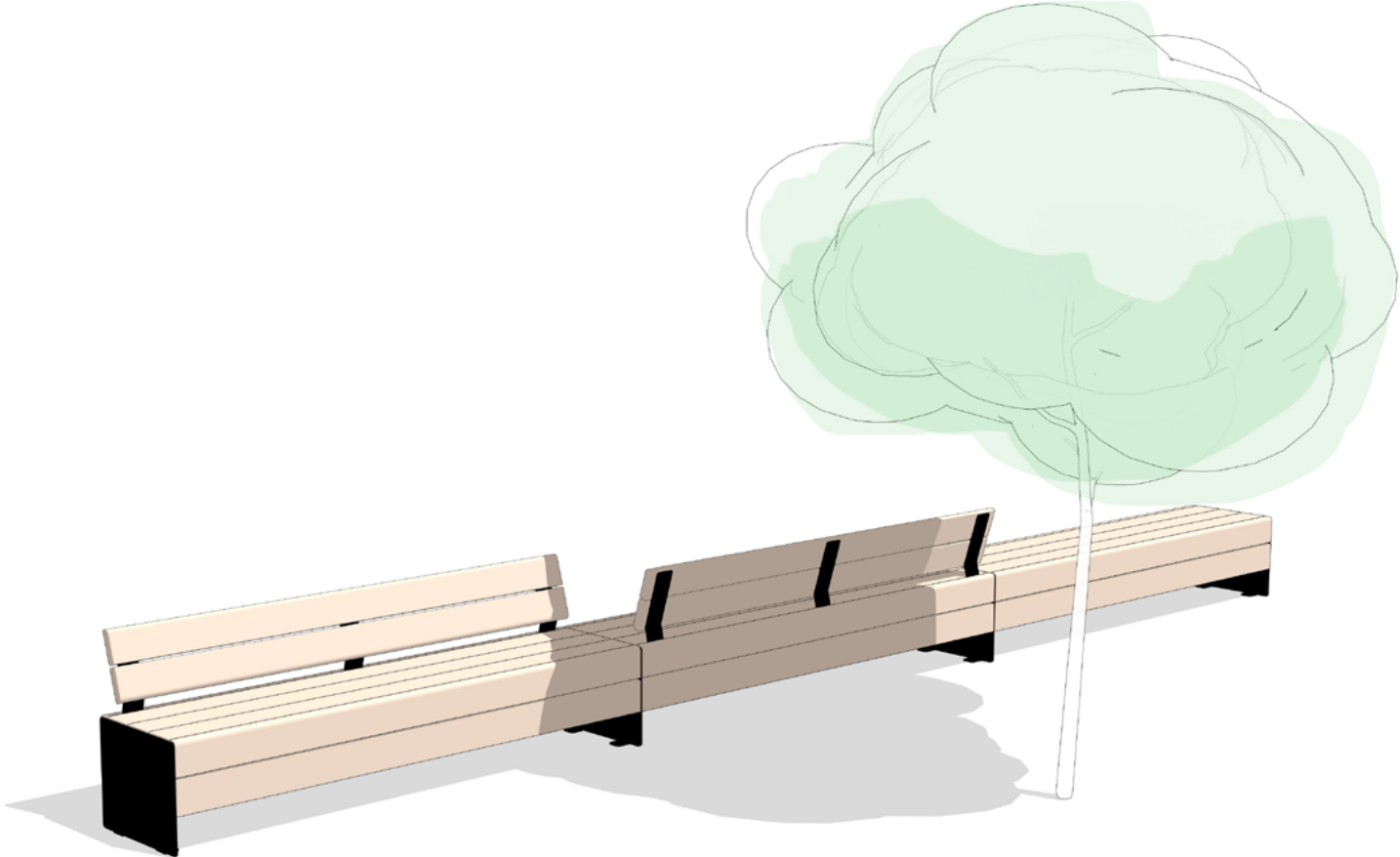

PRODUCTS SHOWN  
IN THIS CONCEPT

- (2) CB-90-1
- (1) CB-90-2
- (2) CBK-90-0

ADD LIGHTING TO  
THIS CONCEPT

- (1) CL-90-S
- (2) CL-90-A

Lighting kits may vary depending on power source.  
One Starter Kit can support up to three additional benches.

BACKS, ARMS & INHIBITORS ALSO AVAILABLE



CB-90-1  
CBK-90-0

CB-90-2  
CBK-90-0

CB-90-1



# Camino Configurations

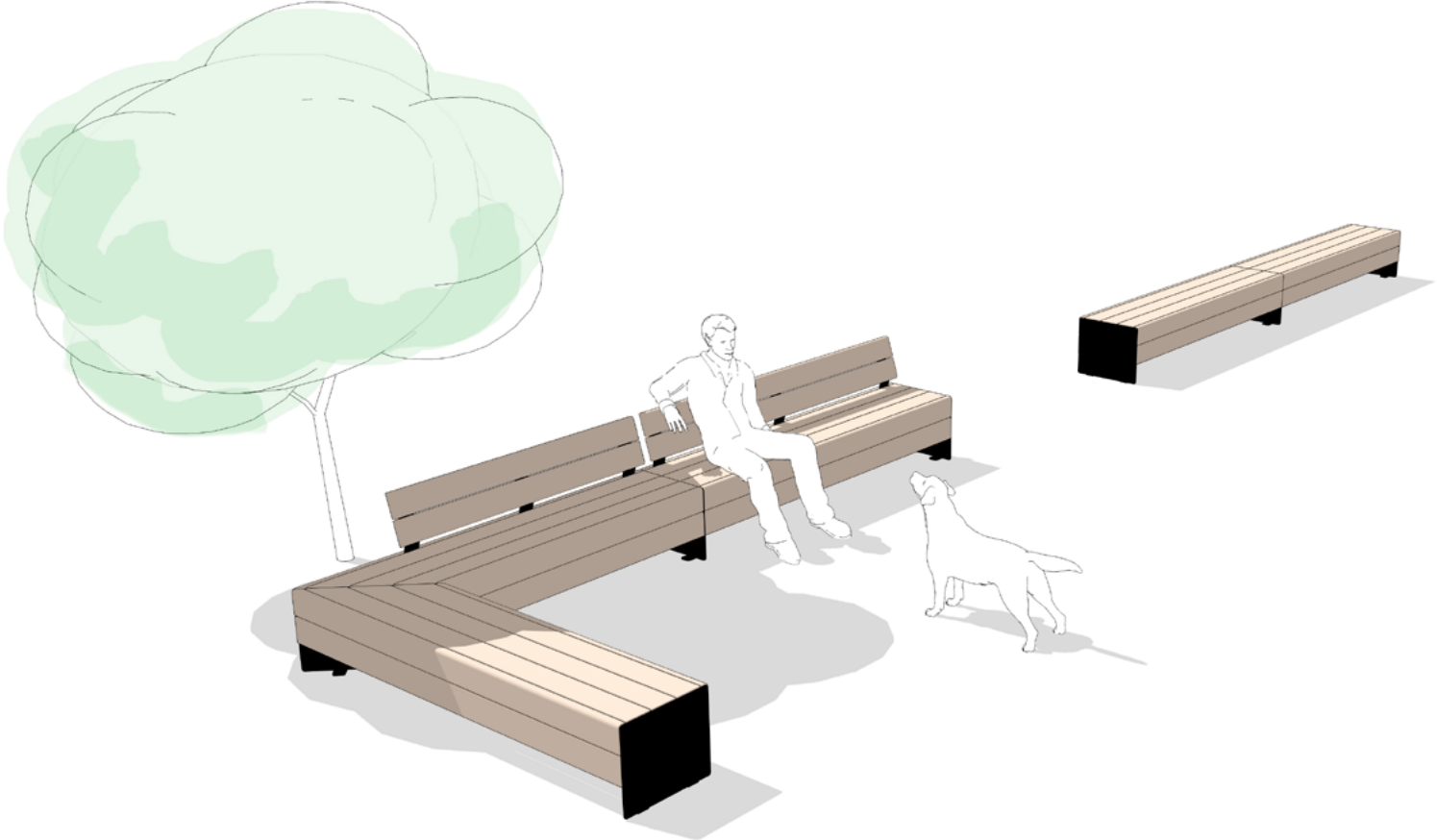

**PRODUCTS SHOWN  
IN THIS CONCEPT**

- (3) CB-90-1
- (1) CBK-90-0
- (1) CB-45L-2
- (1) CBK-45-L2
- (1) CB-45R-1

**ADD LIGHTING TO  
THIS CONCEPT**

- (2) CL-90-A
- (1) CL-90-S
- (1) CL-45-S
- (1) CL-45B-A

Lighting kits may vary depending on power source.  
One Starter Kit can support up to three additional benches.

BACKS, ARMS & INHIBITORS ALSO AVAILABLE

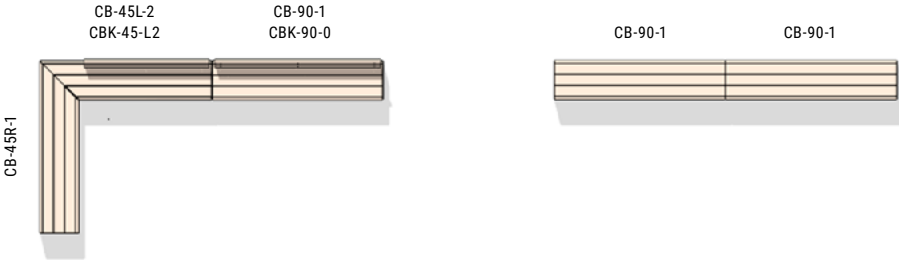

# Camino Configurations

90° CONFIGURATION 1-1

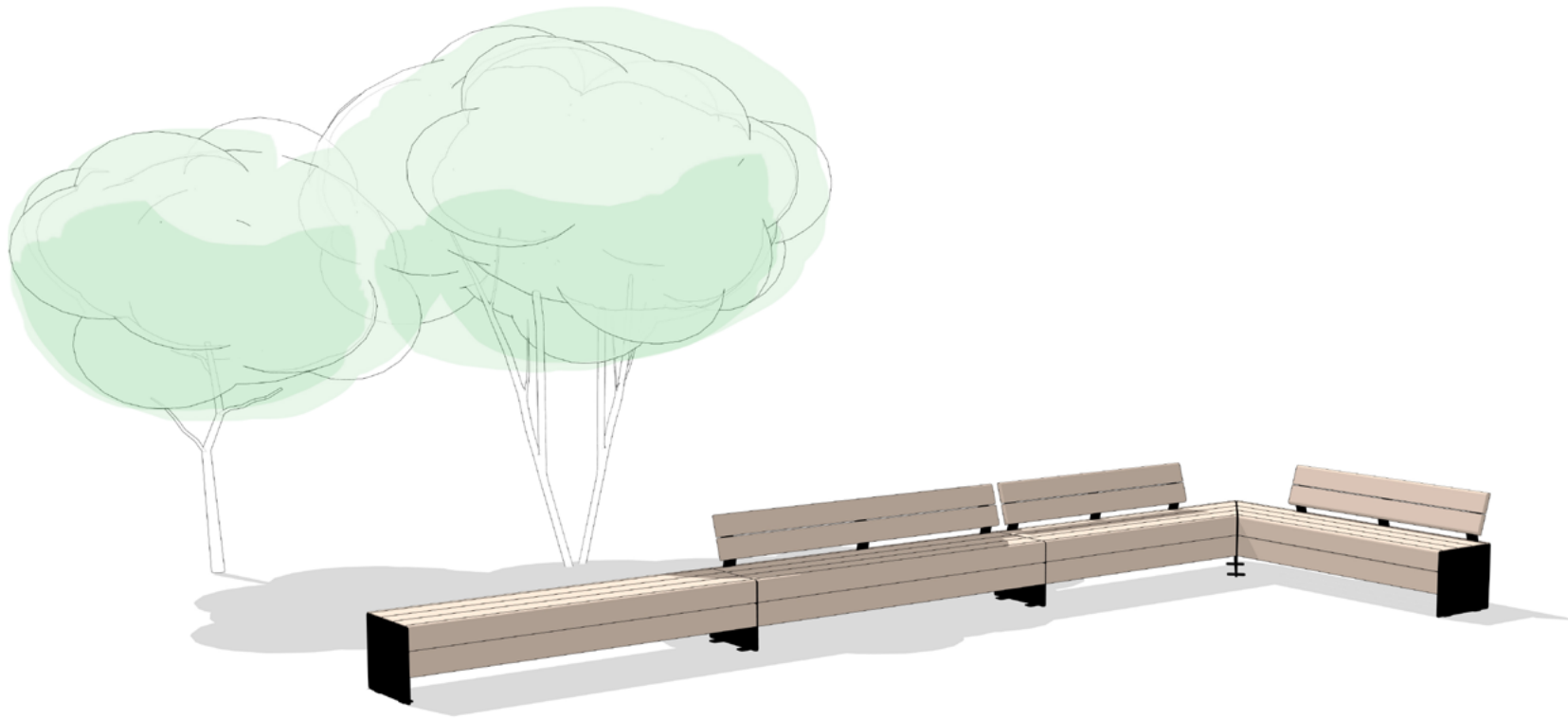

**PRODUCTS SHOWN  
IN THIS CONCEPT**

- (1) CB-90-1
- (1) CB-90-2
- (1) CBK-90-0
- (1) CB-45R-2
- (1) CB-45L-1
- (2) CBK-45-L

**ADD LIGHTING TO  
THIS CONCEPT**

- (1) CL-90-A
- (1) CL-90-S
- (1) CL-45B-S
- (1) CL-45B-A

Lighting kits may vary depending on power source.  
One Starter Kit can support up to three additional benches.

BACKS, ARMS & INHIBITORS ALSO AVAILABLE

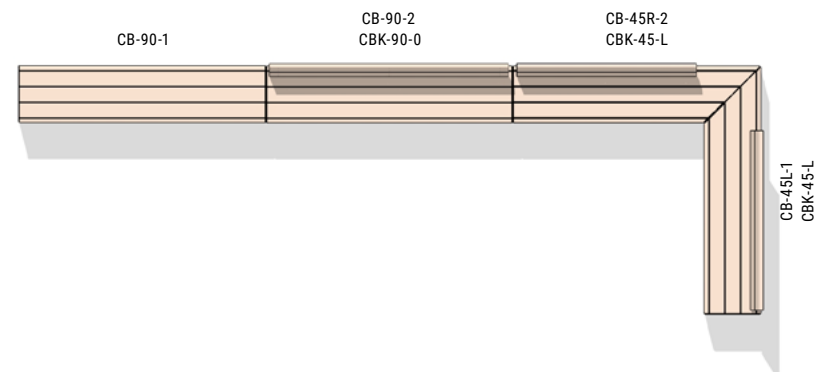

# Camino Configurations

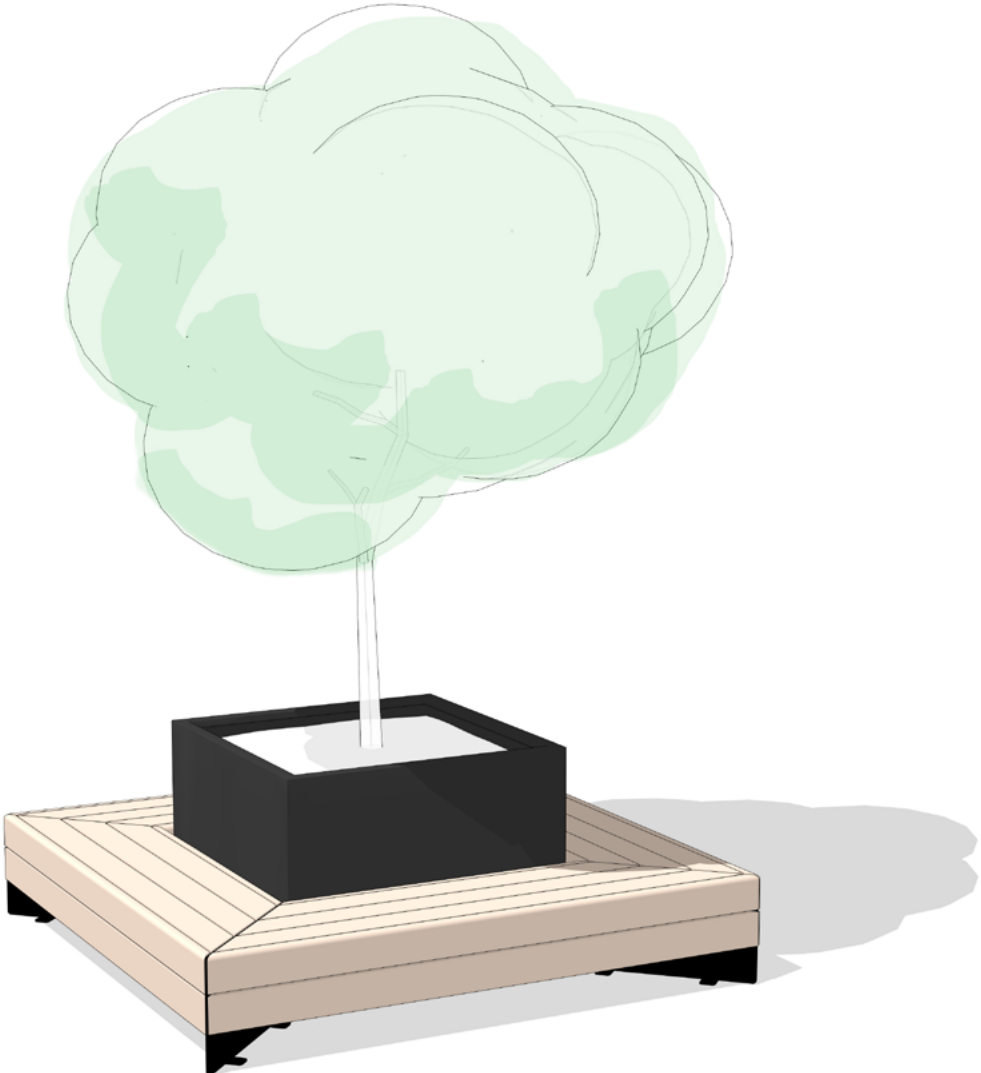

**PRODUCTS SHOWN  
IN THIS CONCEPT**

- (4) CB-45B-2
- (1) WWR-AL606042

**ADD LIGHTING TO  
THIS CONCEPT**

- (1) CL-45B-S
- (3) CL-45B-A

Lighting kits may vary depending on power source.  
One Starter Kit can support up to three additional benches.

BACKS, ARMS & INHIBITORS ALSO AVAILABLE

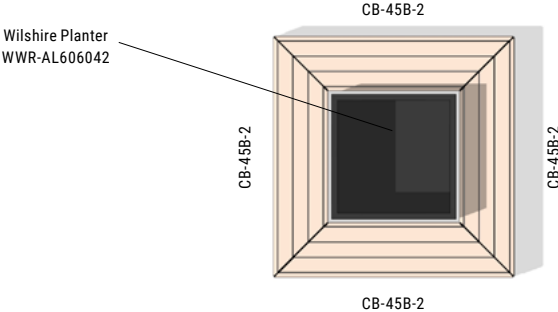

# Camino Configurations

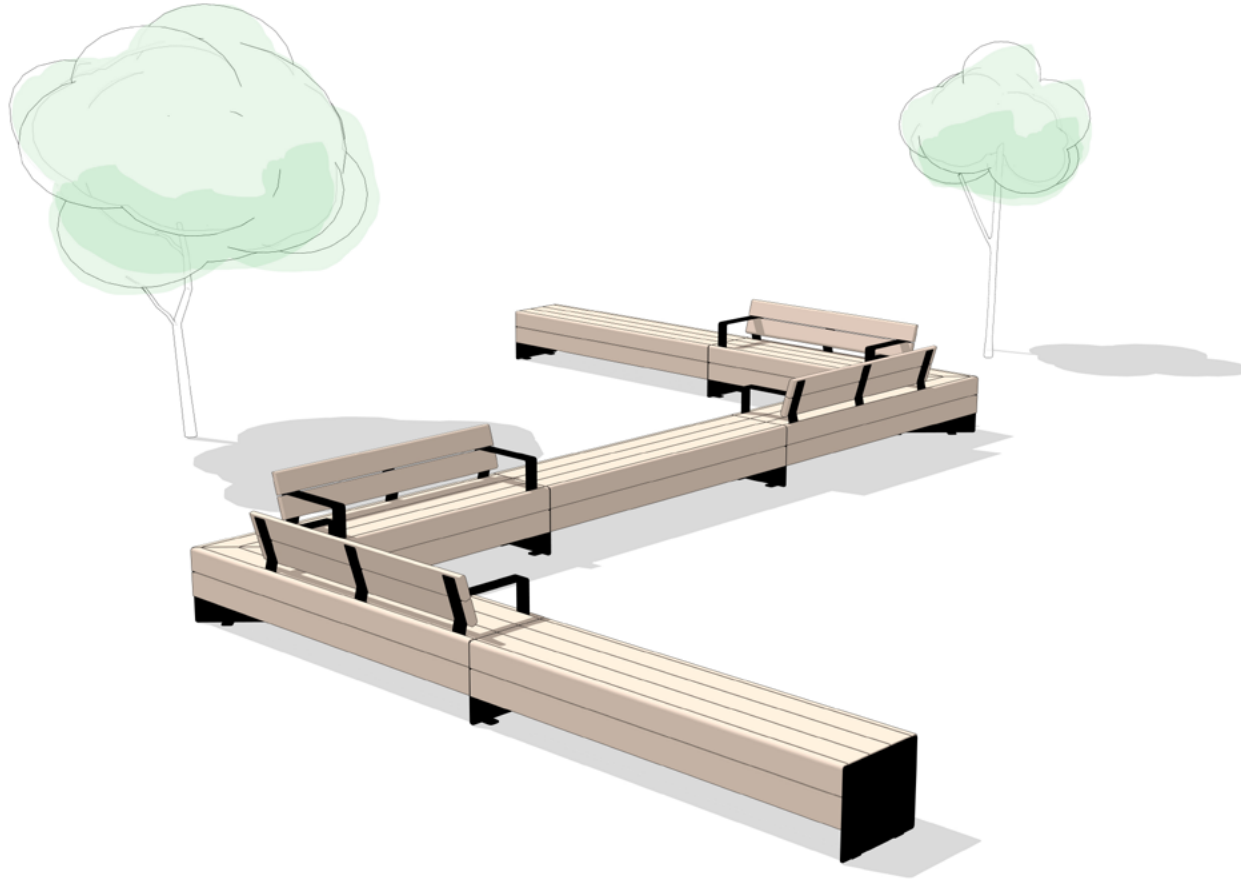

**PRODUCTS SHOWN  
IN THIS CONCEPT**

- (2) CB-90-1
- (1) CB-90-2
- (2) CB-45R-2
- (2) CB-45L-2
- (4) CBK-45-L2

**ADD LIGHTING TO  
THIS CONCEPT**

- (2) CL-45B-S
- (2) CL-45B-A
- (3) CL-90-A

Lighting kits may vary depending on power source.  
One Starter Kit can support up to three additional benches.

BACKS, ARMS & INHIBITORS ALSO AVAILABLE

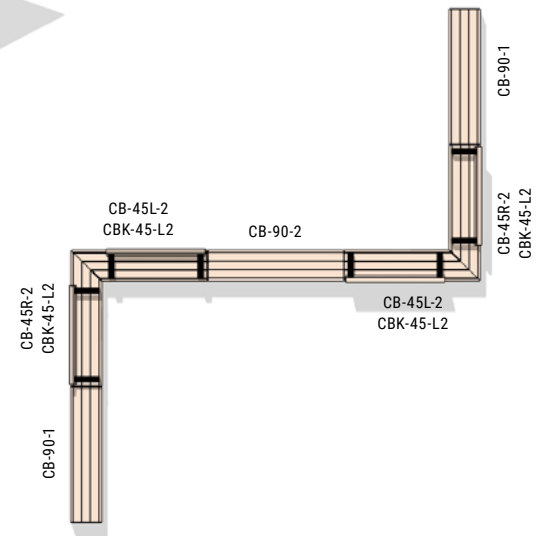

# Camino Configurations

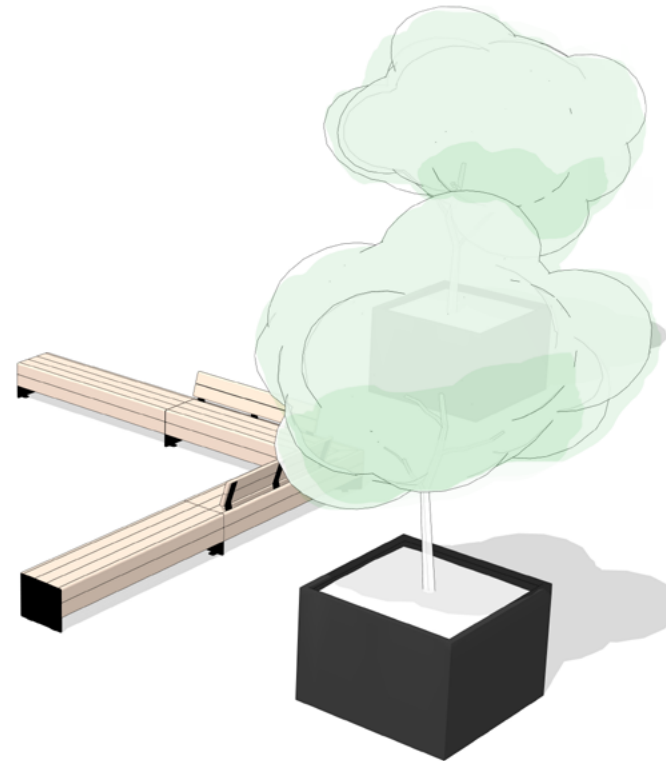
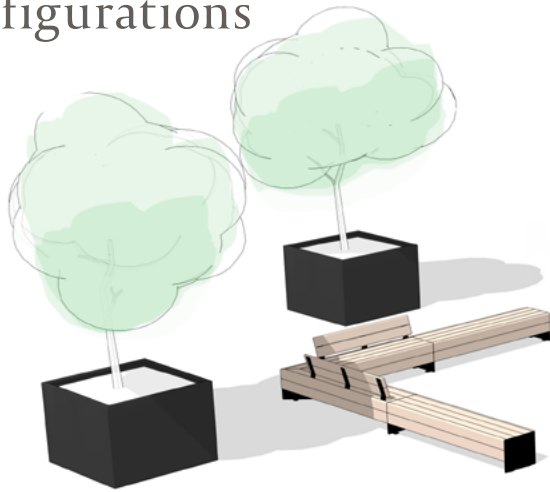

**PRODUCTS SHOWN  
IN THIS CONCEPT**

- (4) CB-90-1
- (2) CB-45R-2
- (2) CB-45L-2
- (4) CBK-45-L2
- (4) WWR-AL606042

**ADD LIGHTING TO  
THIS CONCEPT**

- (2) CL-45B-S
- (6) CL-45B-A

Lighting kits may vary depending on power source.  
One Starter Kit can support up to three additional benches.

BACKS, ARMS & INHIBITORS ALSO AVAILABLE

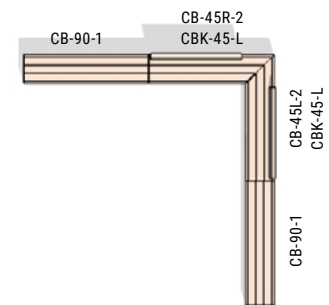
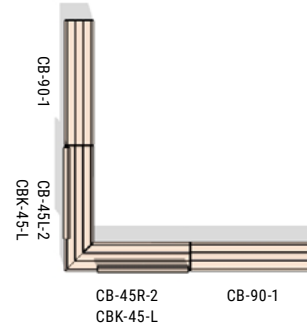

# Camino Configurations

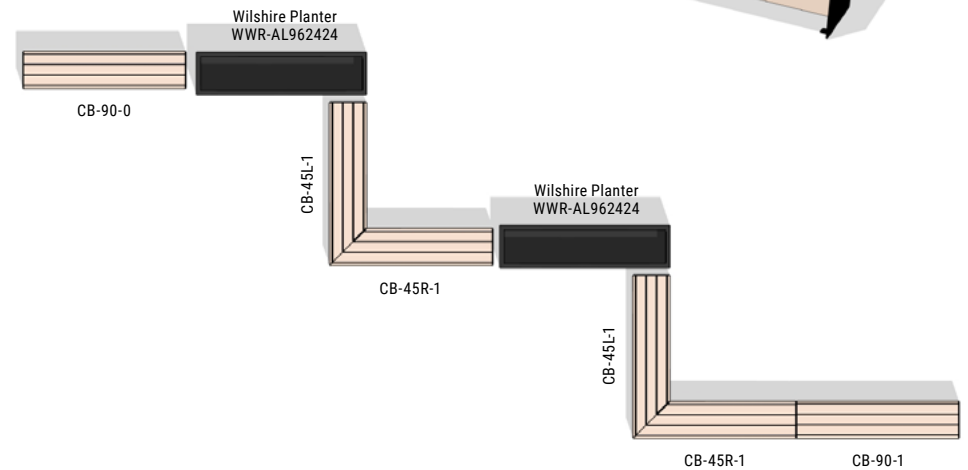
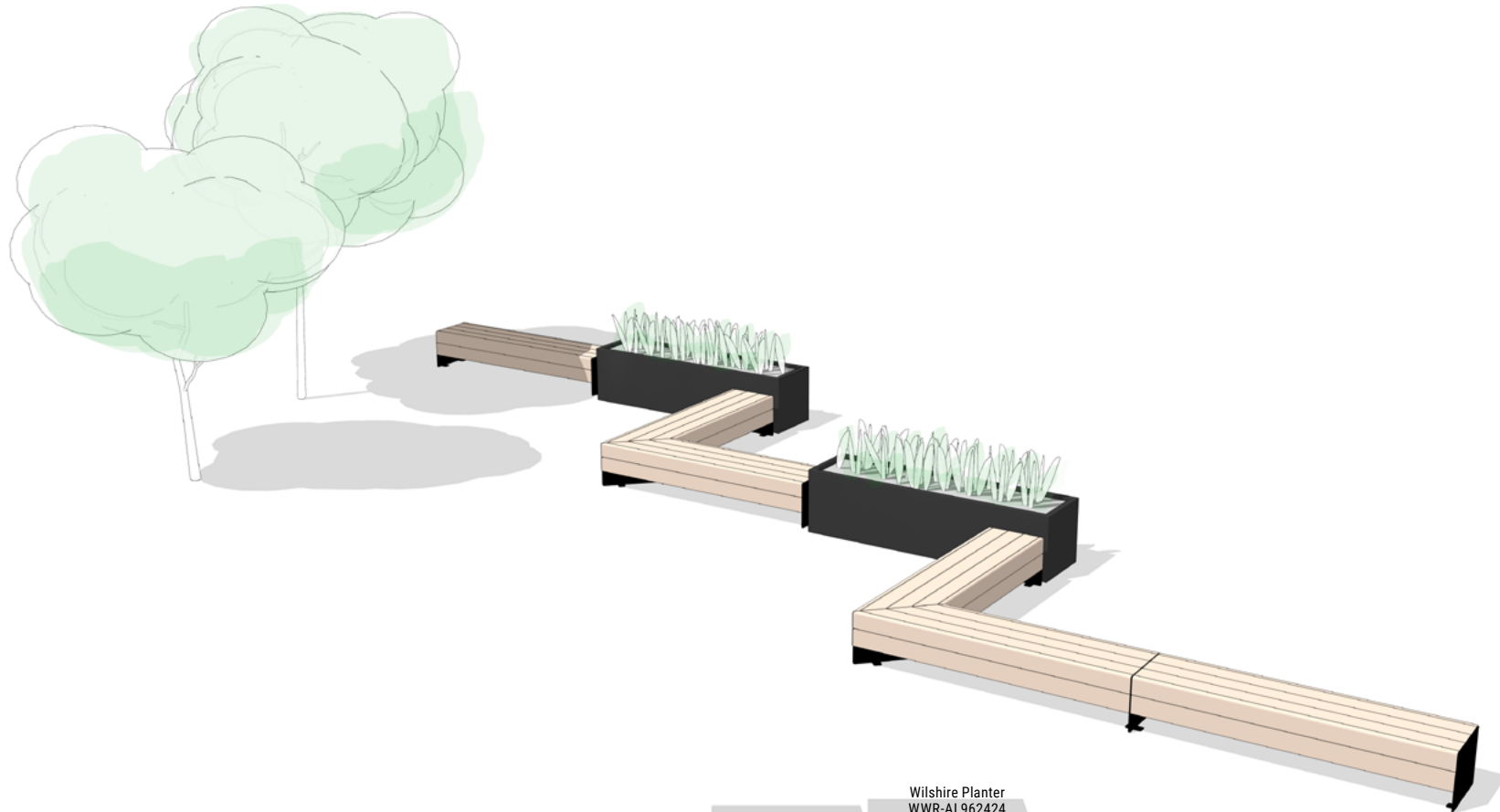

**PRODUCTS SHOWN  
IN THIS CONCEPT**

- (1) CB-90-0
- (1) CB-90-1
- (2) CB-45L-1
- (2) CB-45R-1
- (2) WWR-AL962424

**ADD LIGHTING TO  
THIS CONCEPT**

- (1) CL-90-S
- (1) CL-90-A
- (2) CL-45-S
- (2) CL-45-A

Lighting kits may vary depending on power source.  
One Starter Kit can support up to three additional benches.

BACKS, ARMS & INHIBITORS ALSO AVAILABLE



# Camino Configurations

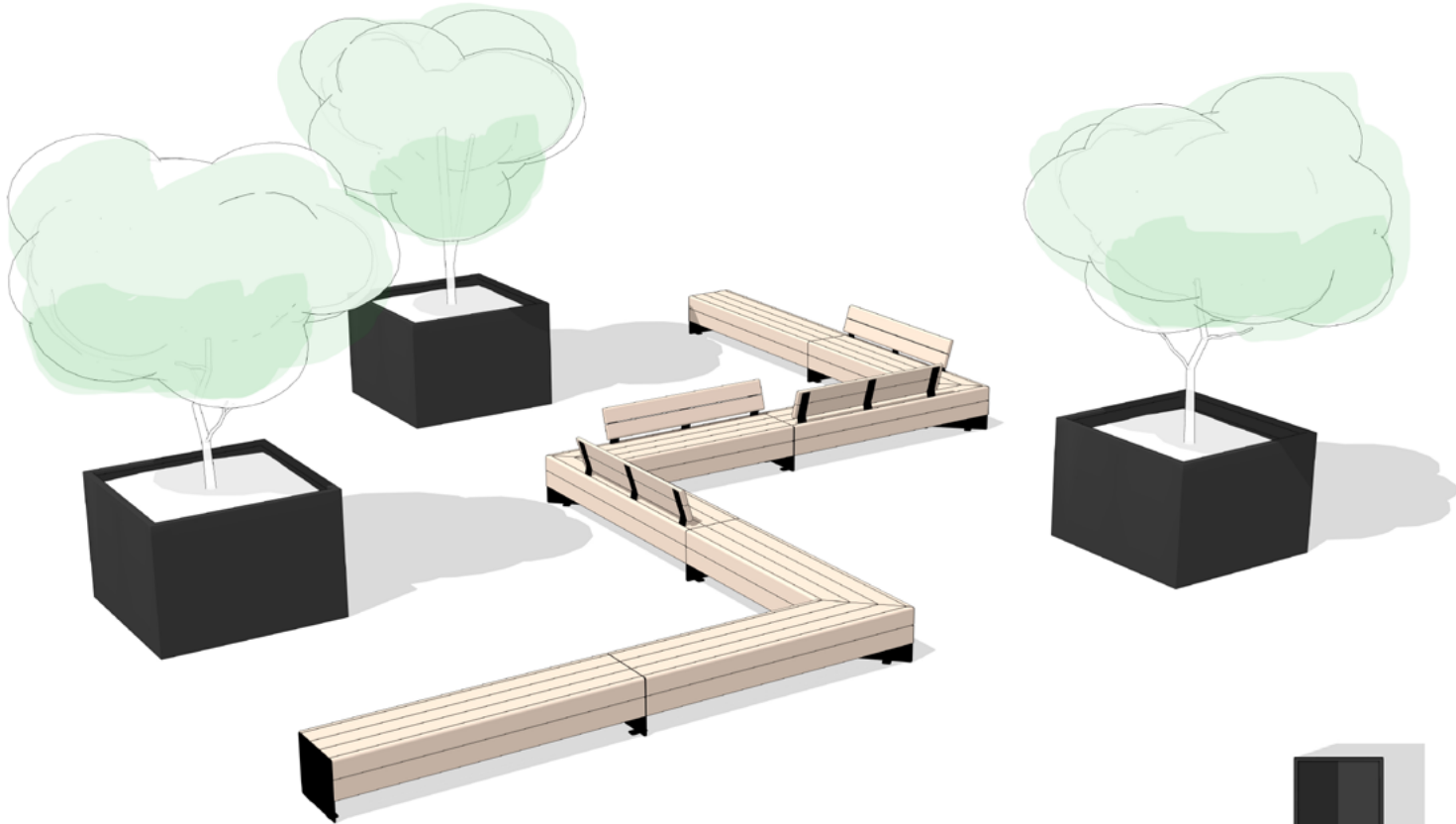

**PRODUCTS SHOWN  
IN THIS CONCEPT**

- (2) CB-90-1
- (2) CB-45R-2
- (2) CB-45L-2
- (4) CBK-45-L
- (1) CB-45R-1
- (1) CB-45L-1
- (4) WWR-AL606042

**ADD LIGHTING TO  
THIS CONCEPT**

- (2) CL-90-A
- (2) CL-45-S
- (4) CL-45-A

Lighting kits may vary depending on power source.  
One Starter Kit can support up to three additional benches.

BACKS, ARMS & INHIBITORS ALSO AVAILABLE

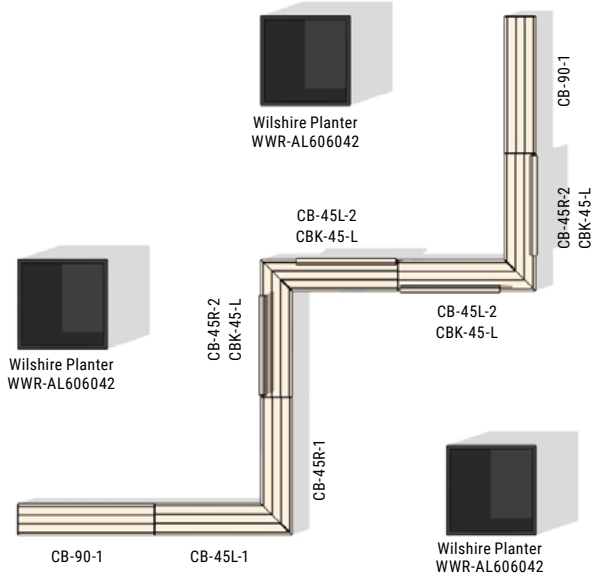

# Camino Configurations

120° CONFIGURATION 2-3

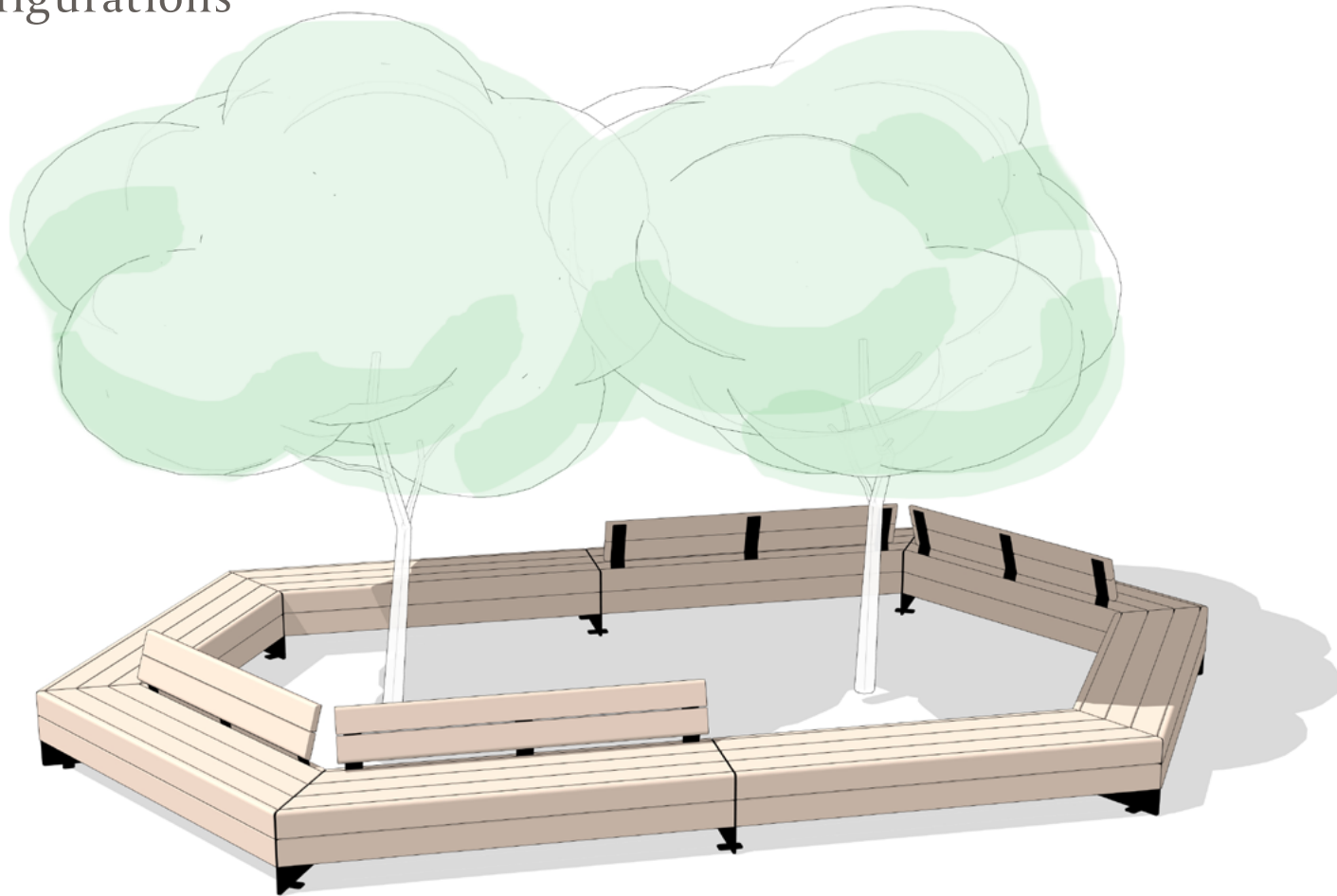

**PRODUCTS SHOWN  
IN THIS CONCEPT**

- (4) CB-60B-2
- (2) CB-60R-2
- (2) CB-60L-2
- (2) CBK-60-0
- (2) CBK-60-S

**ADD LIGHTING TO  
THIS CONCEPT**

- (4) CL-60-B
- (2) CL-60-S
- (2) CL-60-A

Lighting kits may vary depending on power source.  
One Starter Kit can support up to three additional benches.

**BACKS, ARMS & INHIBITORS ALSO AVAILABLE**

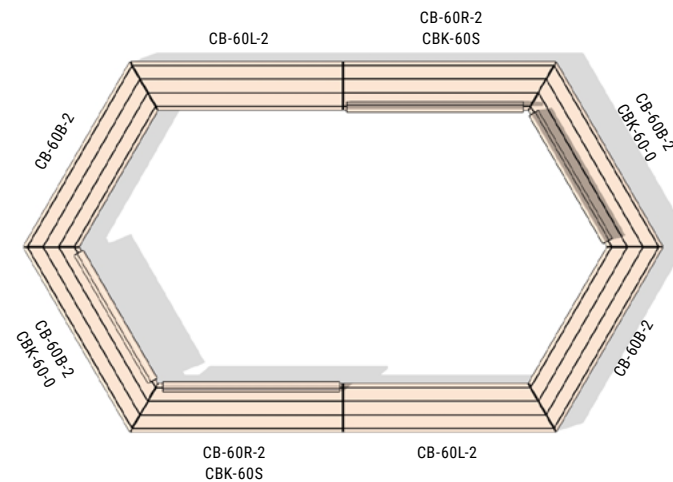

# Camino Configurations

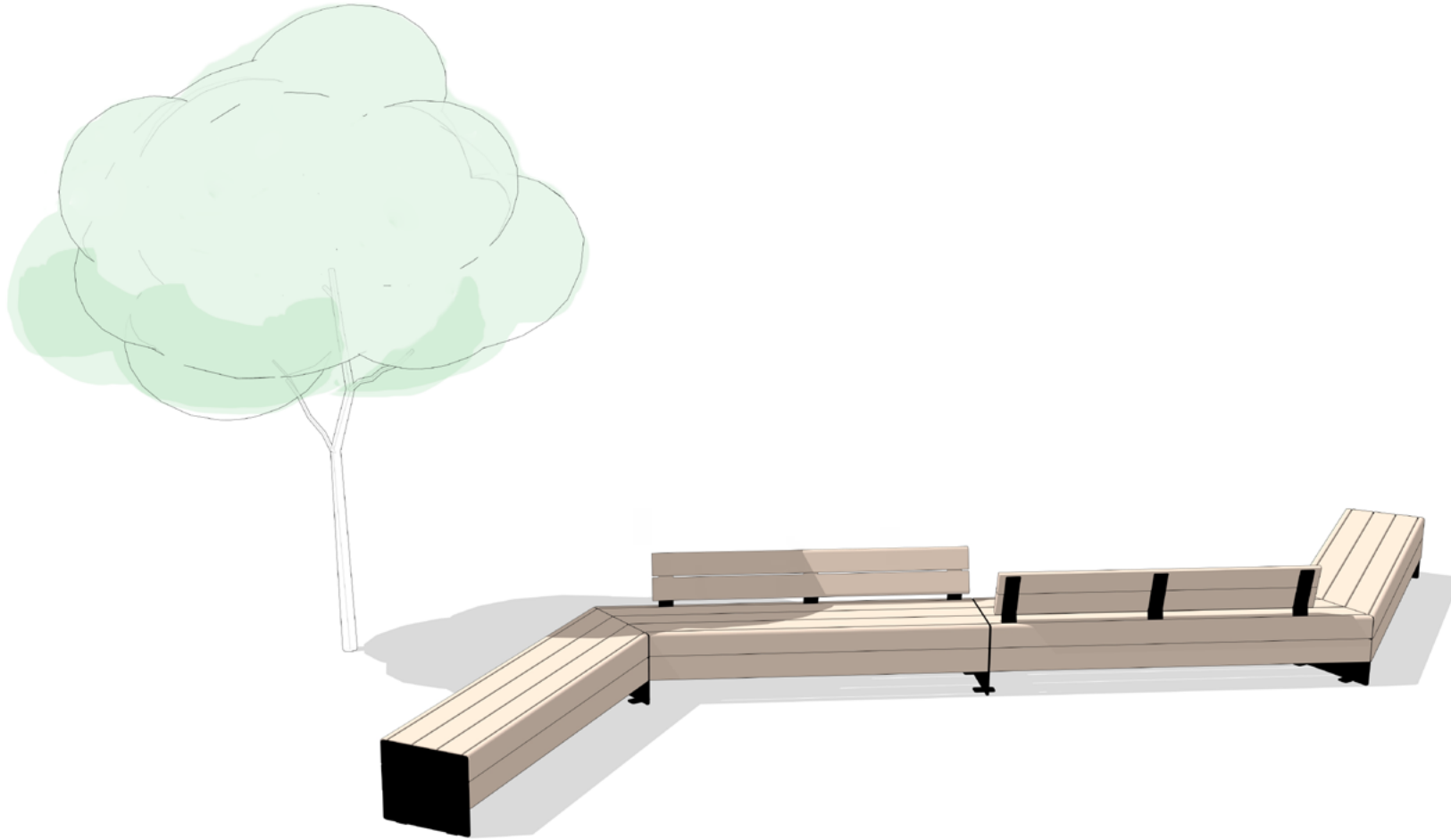

**PRODUCTS SHOWN  
IN THIS CONCEPT**

- (2) CB-60R-1
- (2) CB-60L-2
- (2) CBK-60L

**ADD LIGHTING TO  
THIS CONCEPT**

- (1) CL-60-S
- (1) CL-60-A
- (2) CL-60B-A

Lighting kits may vary depending on power source.  
One Starter Kit can support up to three additional benches.

BACKS, ARMS & INHIBITORS ALSO AVAILABLE

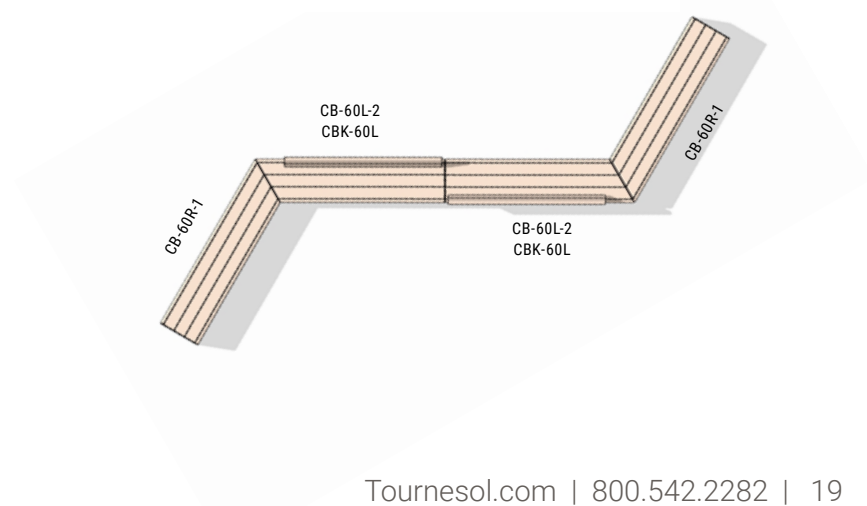

# Camino Configurations

120° CONFIGURATION 2-2

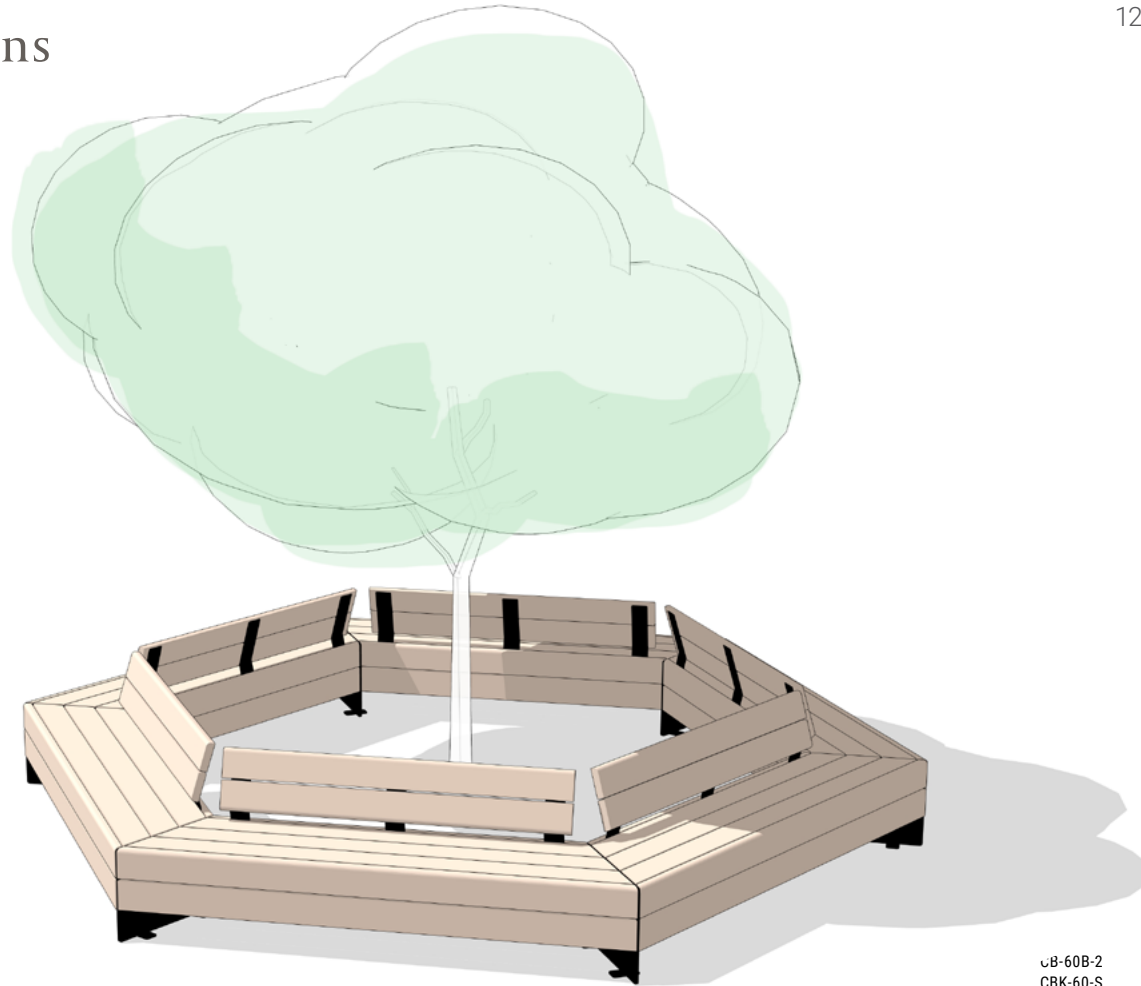

PRODUCTS SHOWN  
IN THIS CONCEPT

- (6) CB-60B-2
- (6) CBK-60-S

ADD LIGHTING TO  
THIS CONCEPT

- (2) CL-60-S
- (4) CL-60-A

Lighting kits may vary depending on power source.  
One Starter Kit can support up to three additional benches.

BACKS, ARMS & INHIBITORS ALSO AVAILABLE

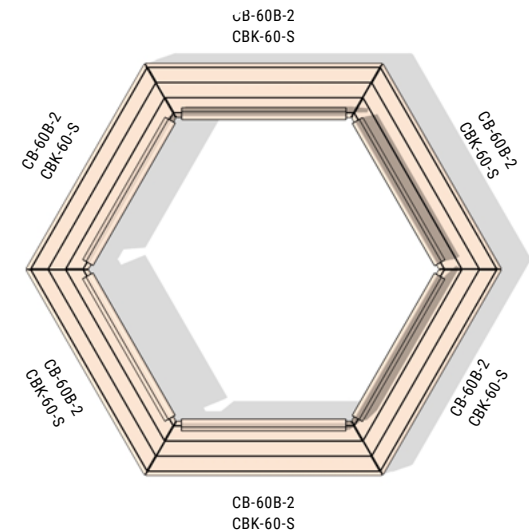

# Camino Configurations

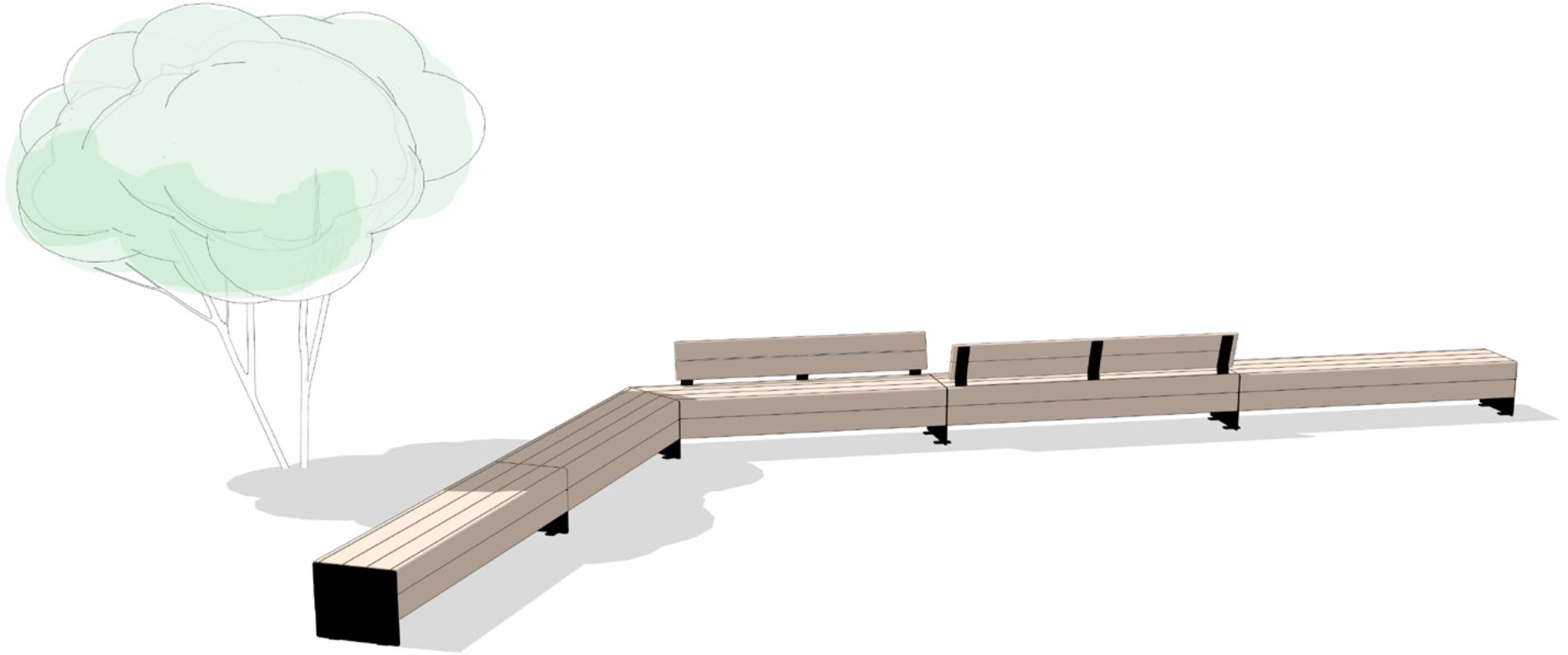

**PRODUCTS SHOWN  
IN THIS CONCEPT**

- (2) CB-90-1
- (1) CB-60R-2
- (1) CB-60L-2
- (1) CBK-60-L
- (1) CB-90-2
- (1) CBK-90-0

**ADD LIGHTING TO  
THIS CONCEPT**

- (2) CL-90-S
- (2) CL-60-A
- (1) CL-90-A

Lighting kits may vary depending on power source.  
One Starter Kit can support up to three additional benches.

BACKS, ARMS & INHIBITORS ALSO AVAILABLE

